

ATTACHMENT I

(Pictures of the EUT and Electrical Schemes)

1 PICTURES

Front view



Back view



Side View



Internal view of enclosure

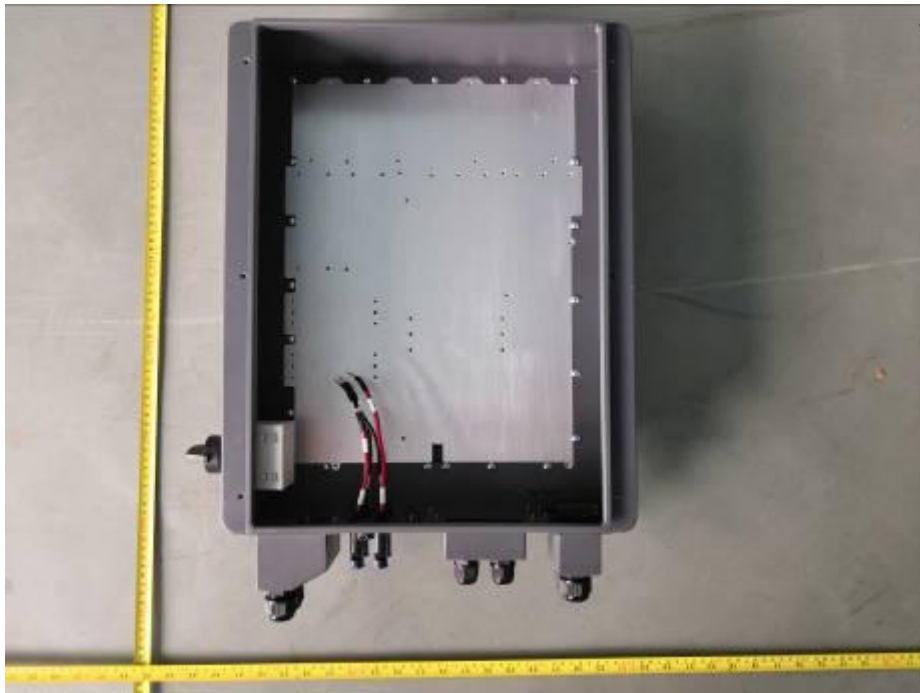

Top View



Internal View of Model HYD 5000-ES, HYD 6000-ES



Internal View of Model HYD 3000-ES, HYD 3600-ES, HYD 4000-ES



Grounding



AC Ternimals

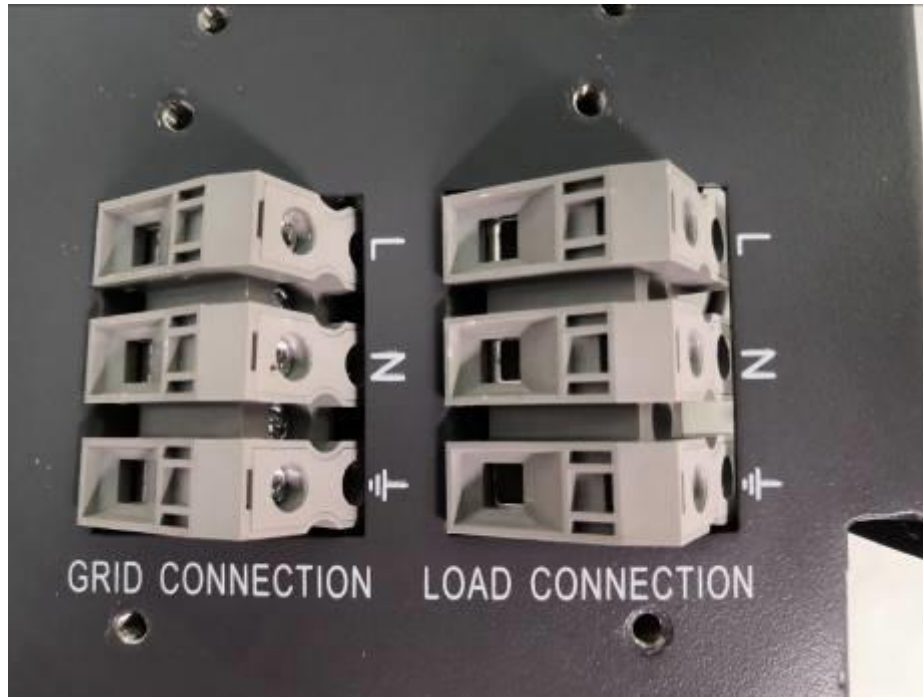

DC Ternimals

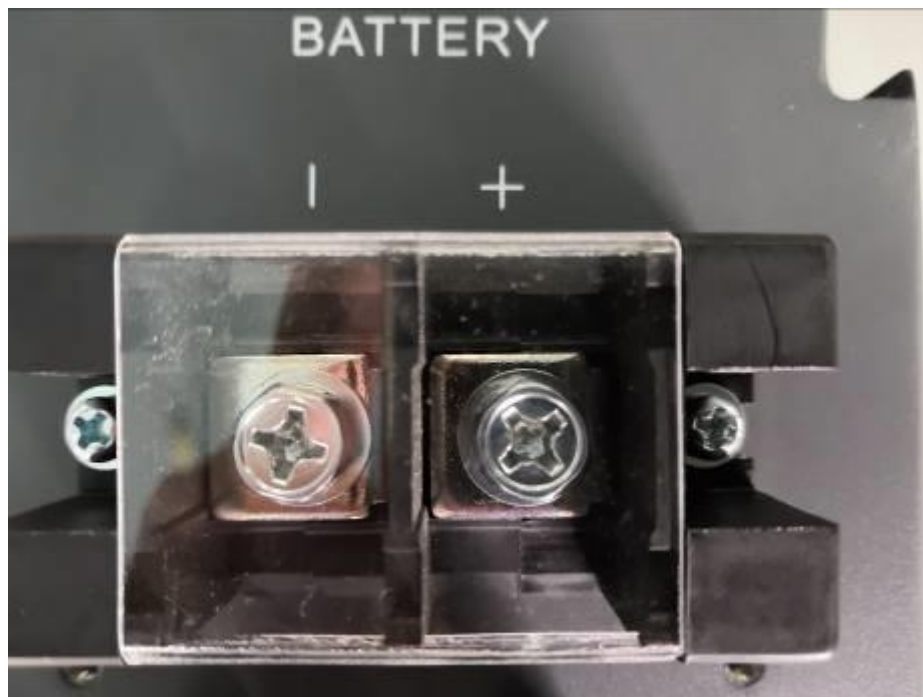

Front View of Power board

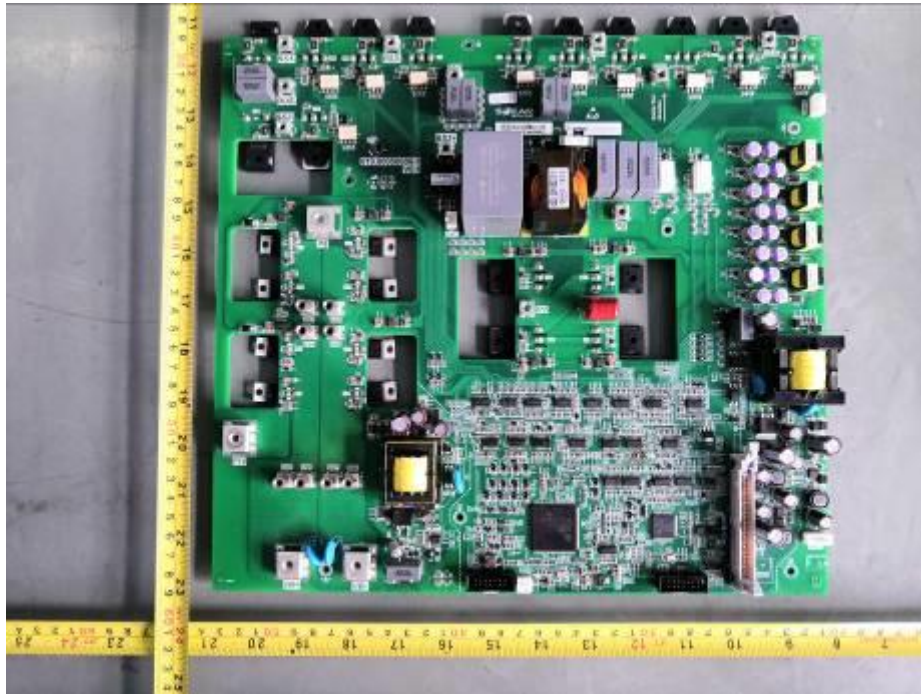

Back View of Power board

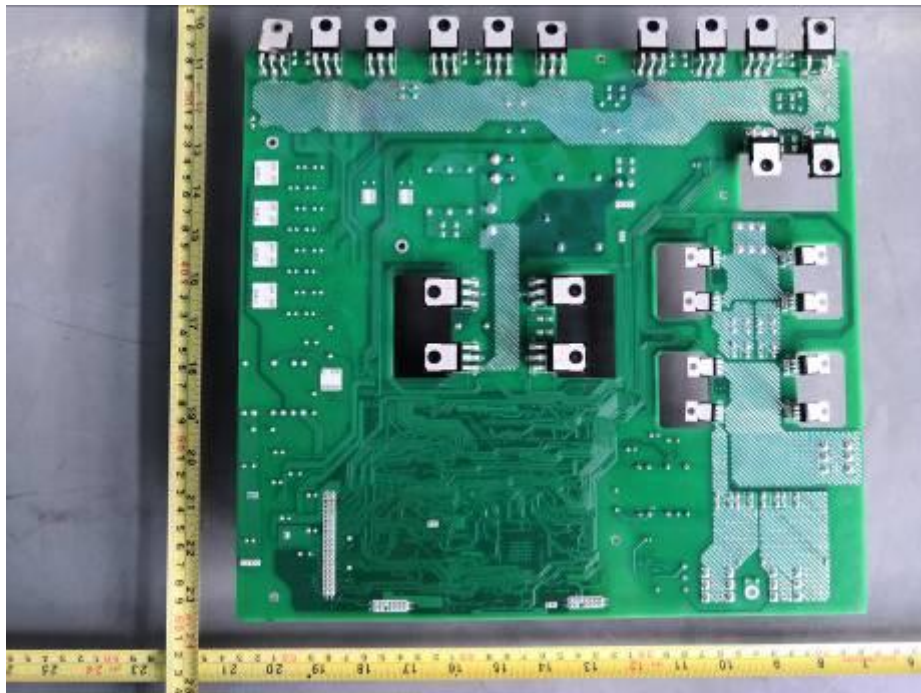

Front View of Input,output and communication board

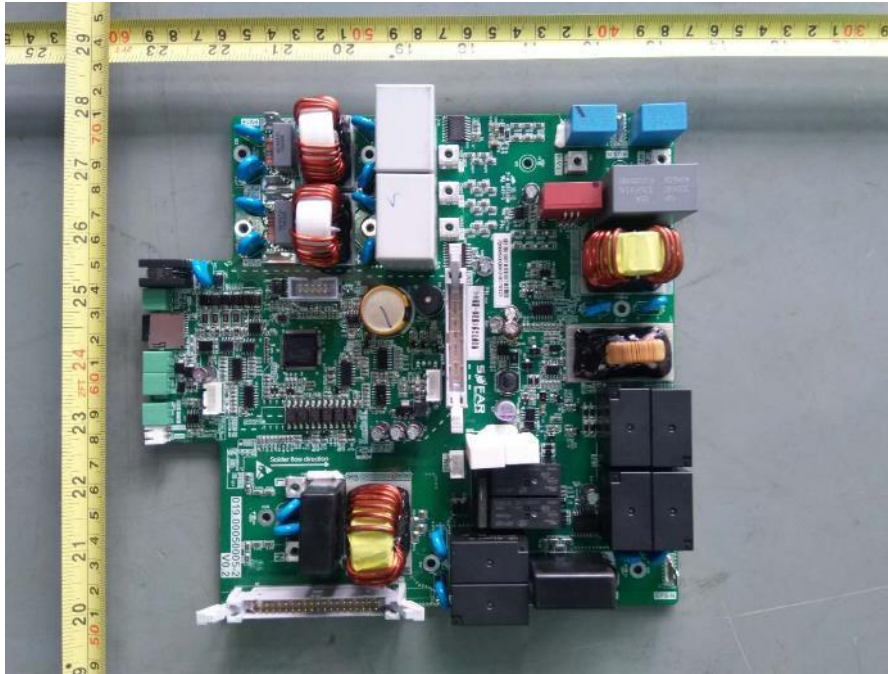

Back View of Input,output and communication board

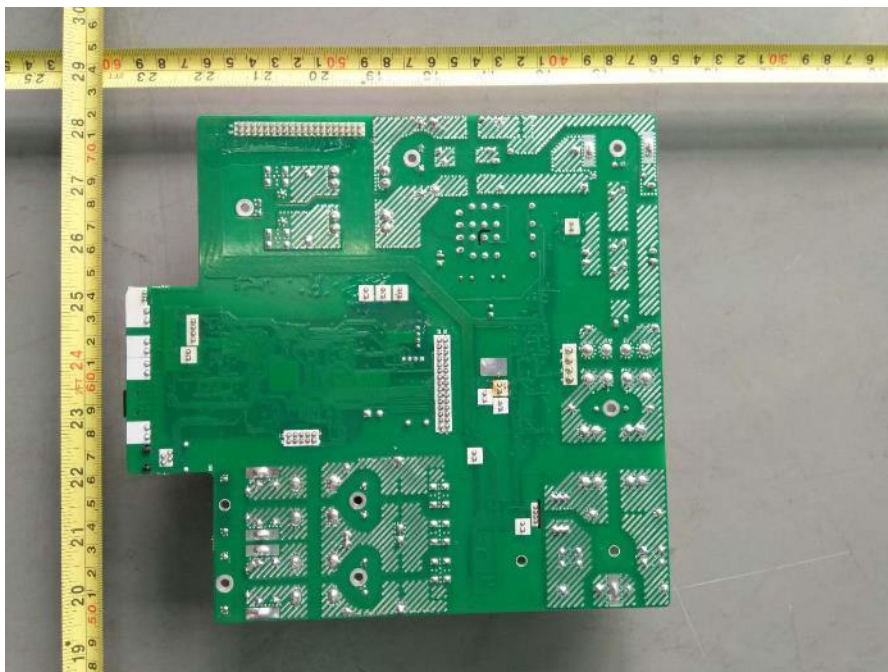

Front View of HYD 5000-ES, HYD 6000-ES Cap. board



Back View of HYD 5000-ES, HYD 6000-ES Cap. board

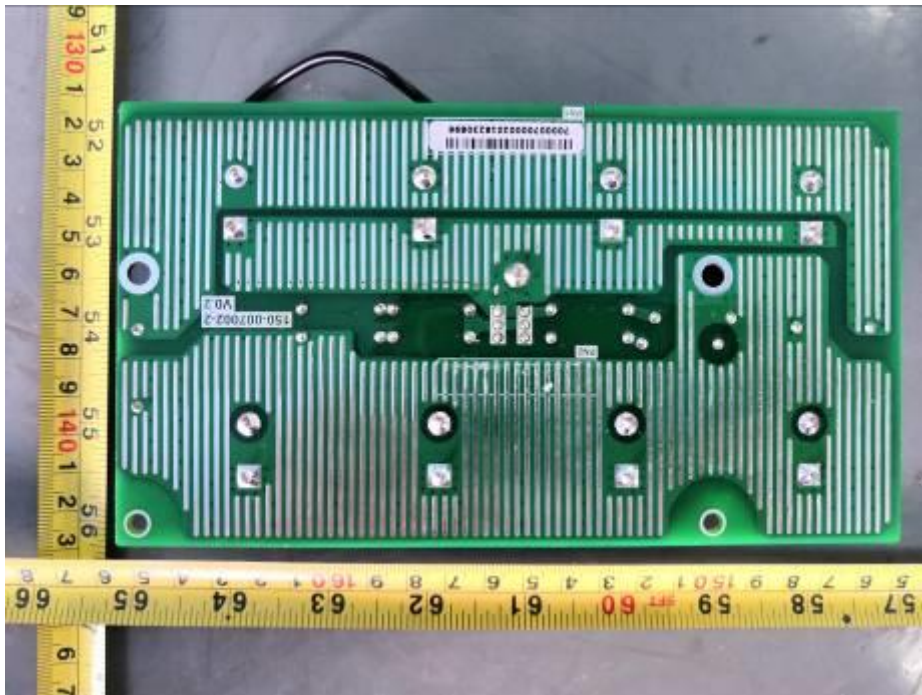

Front View of HYD 3000-ES, HYD 3600-ES, HYD 4000-ES Cap. board



Back View of HYD 3000-ES, HYD 3600-ES, HYD 4000-ES Cap. board

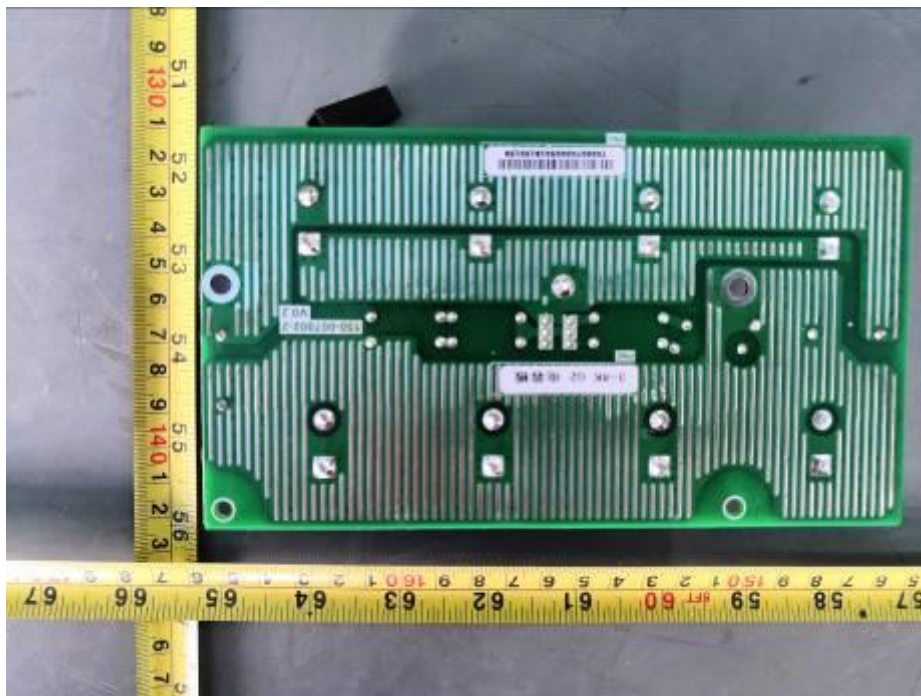

Front View of Cap board B



Back View of Cap board B

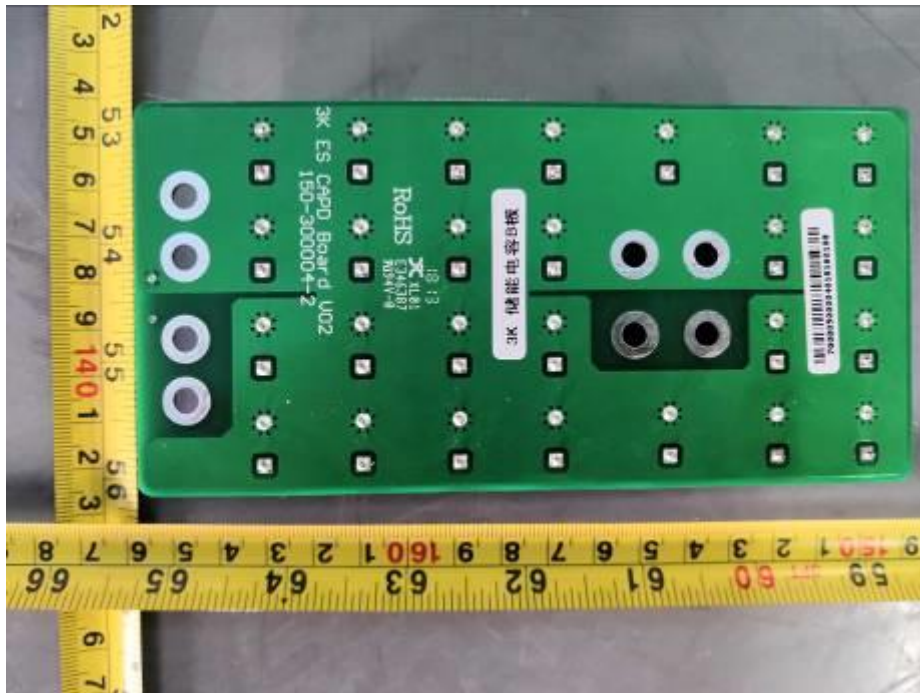

Front View of Cap board A

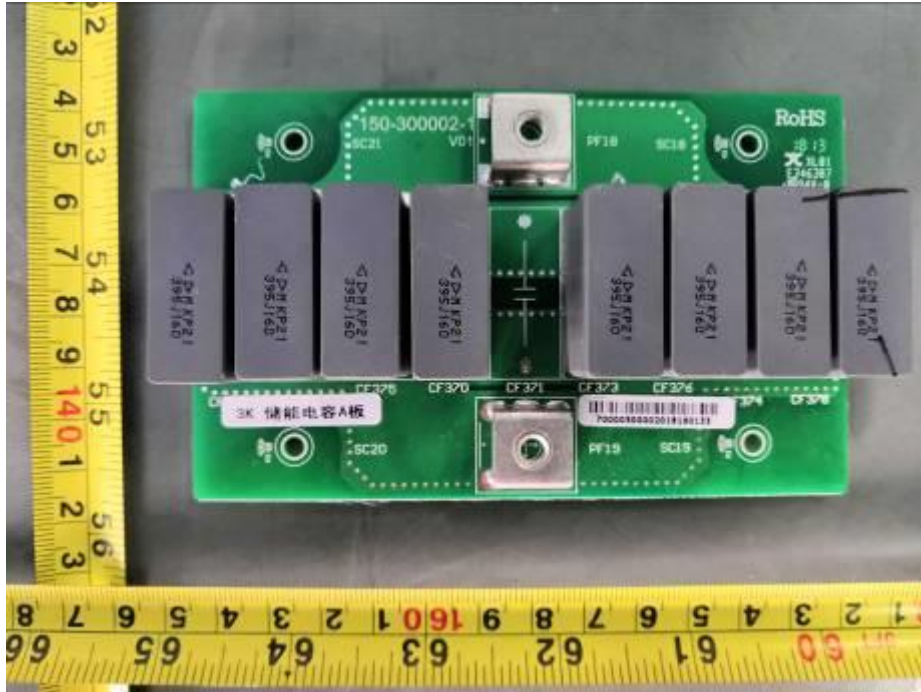

Back View of Cap board A

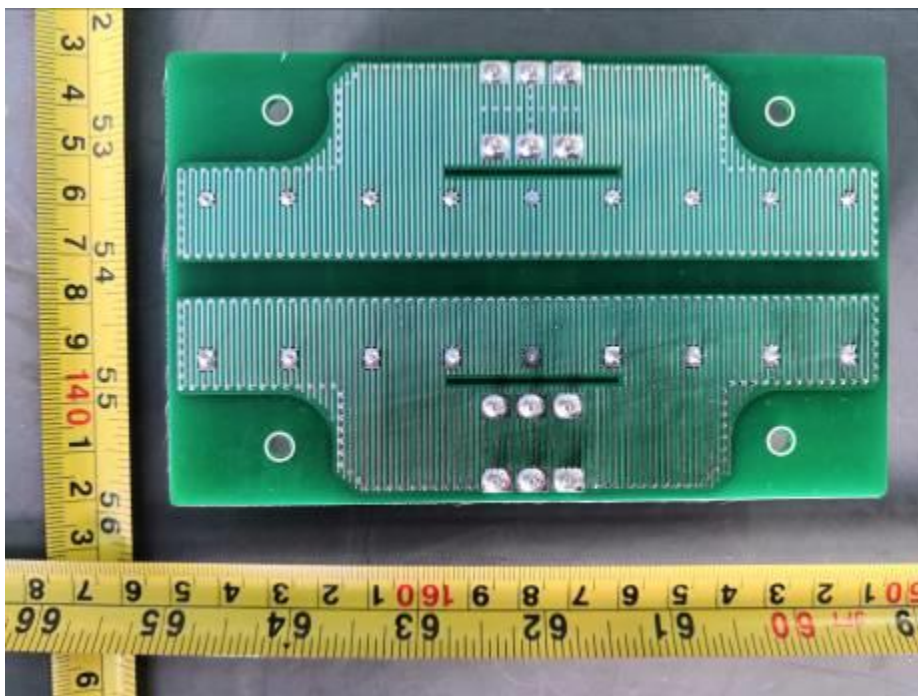

Front view of LED board



Back view of LED board

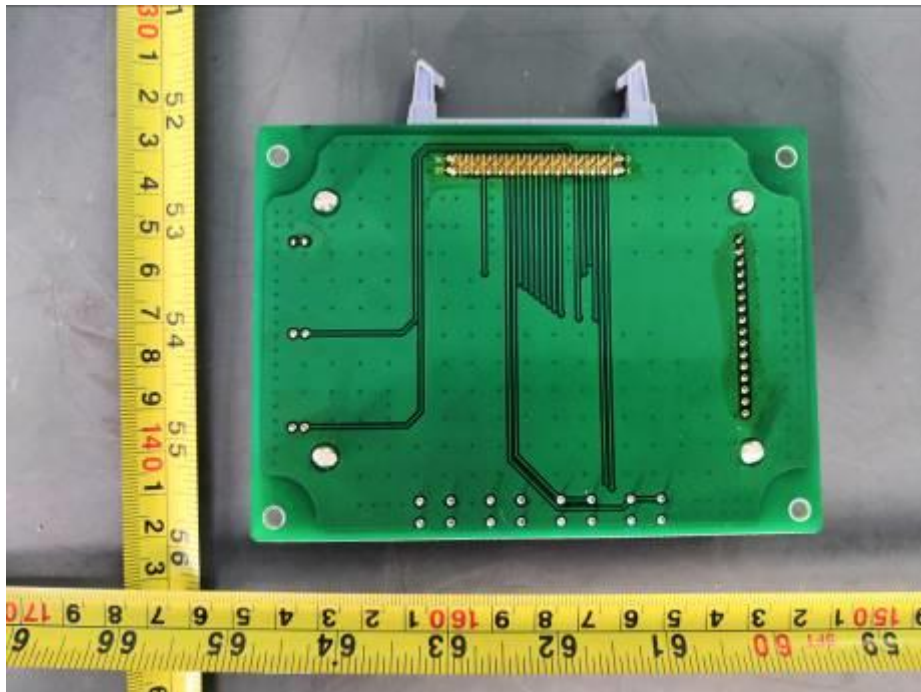

Front view of RS 232 board



Back view of RS 232 board



IEC 62116:2014 (50Hz)

Serial Number and Software Version

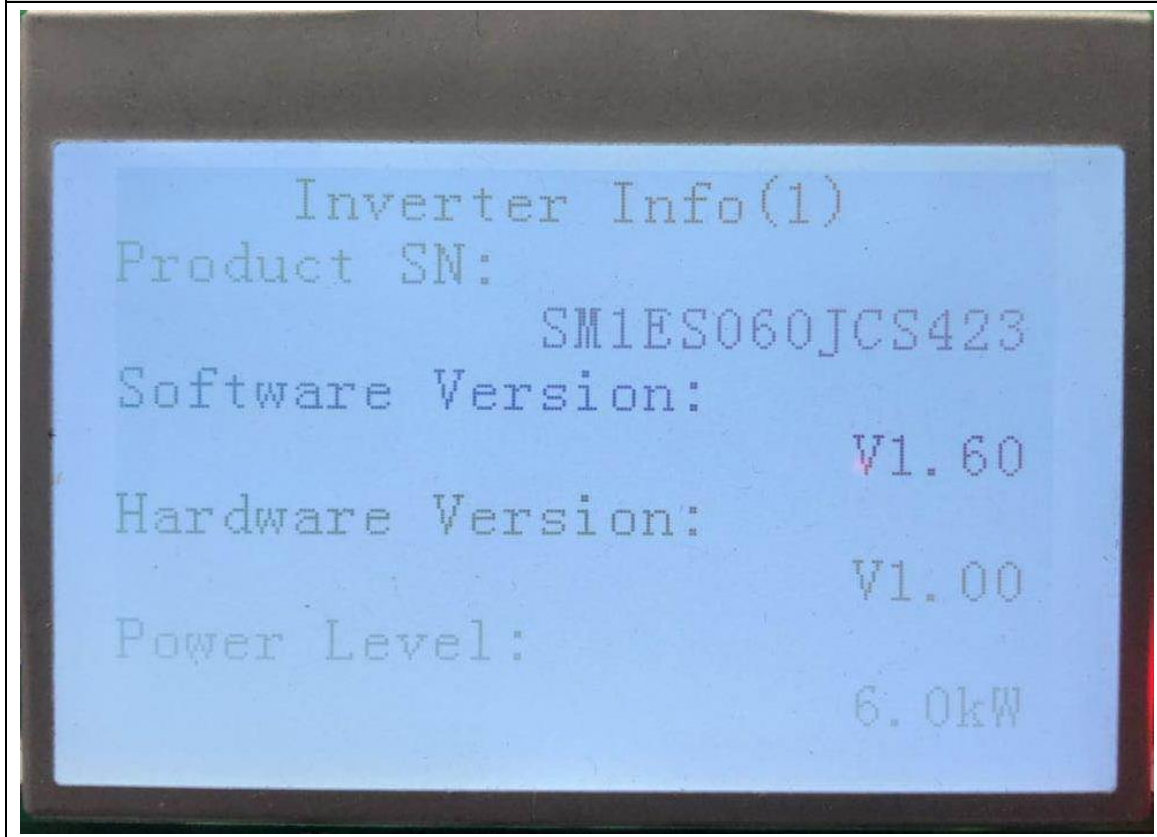

2 ELECTRICAL SCHEMES

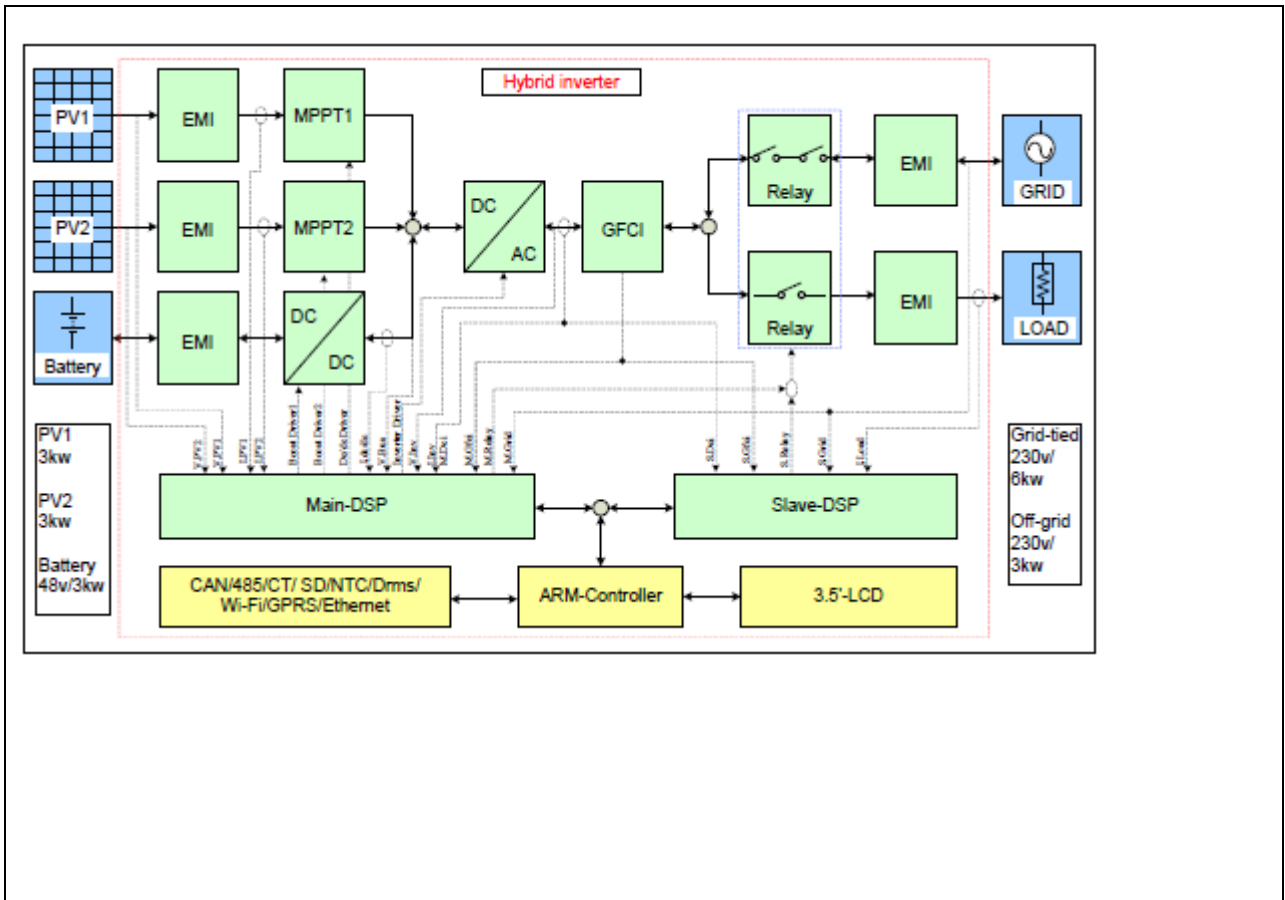

ATTACHMENT II

(GRAPHICS OF THE TEST RESULTS)

Test Condition A

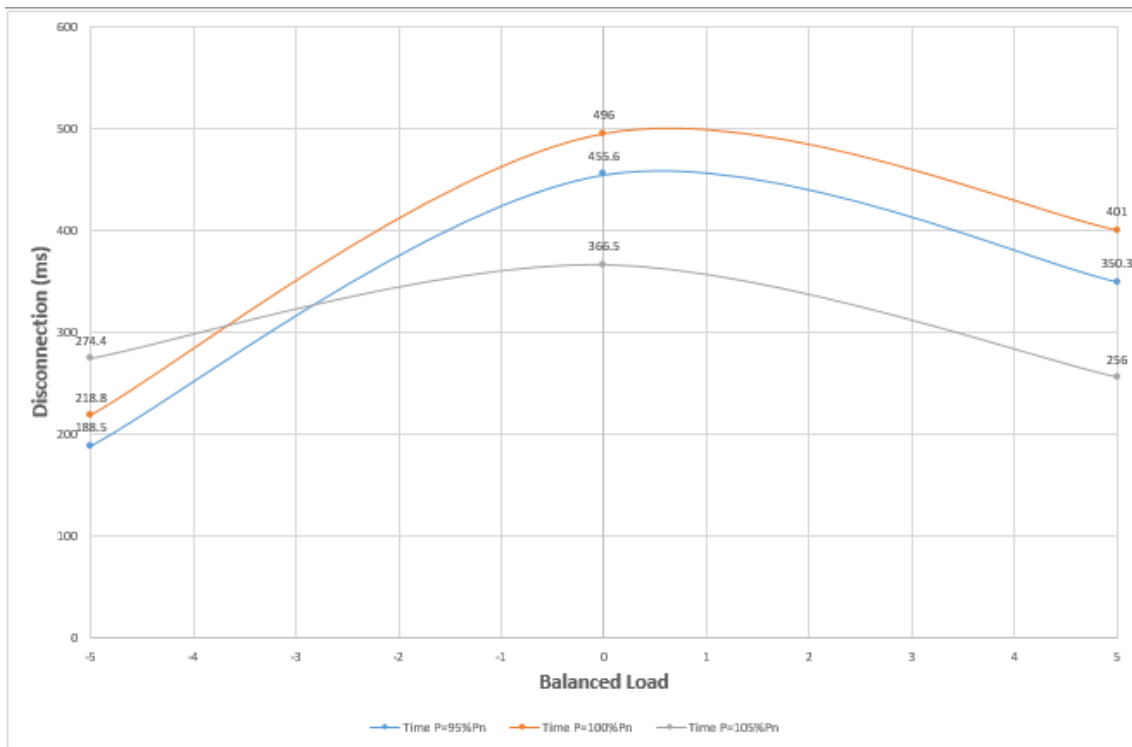

Test Condition B

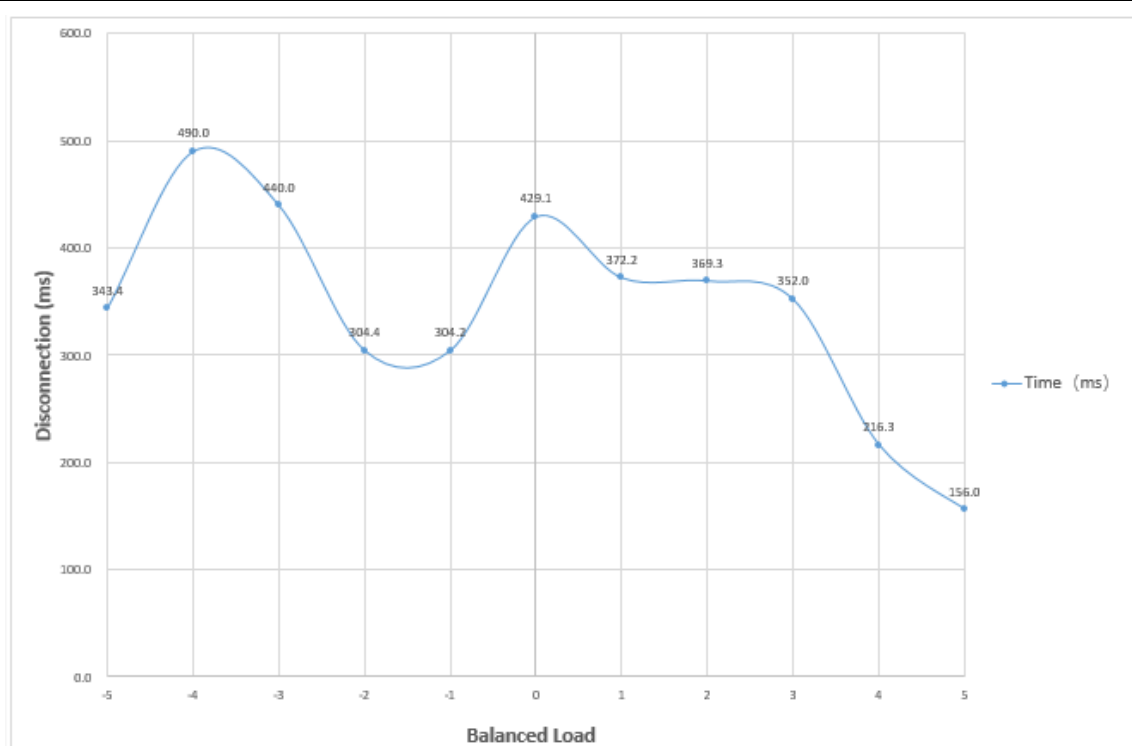

IEC 62116:2014 (50Hz)

Test Condition C

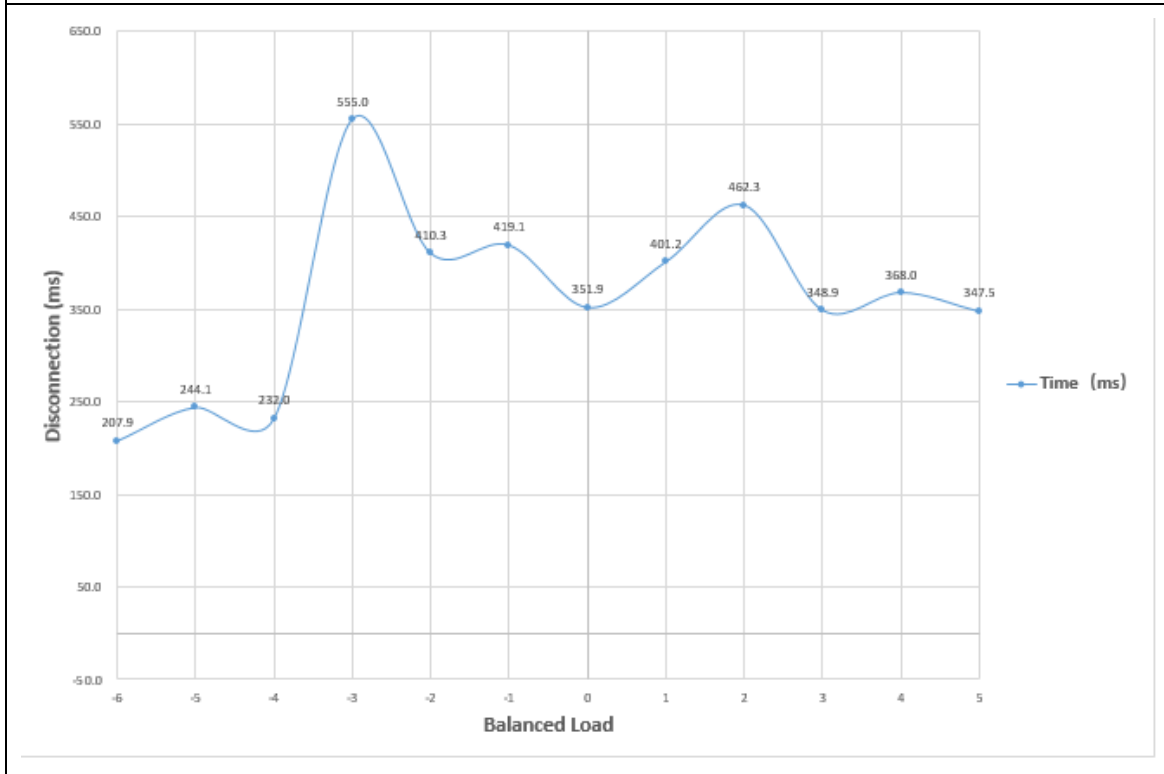

ATTACHMENT III

(GRAPHICS OF THE ISLANDING BEHAVIOR DETECTION)

1 DEFINITIONS

- M It represents the % change in active load from nominal output power
- N It represents the % change in reactive load from nominal output power

2 LEGEND

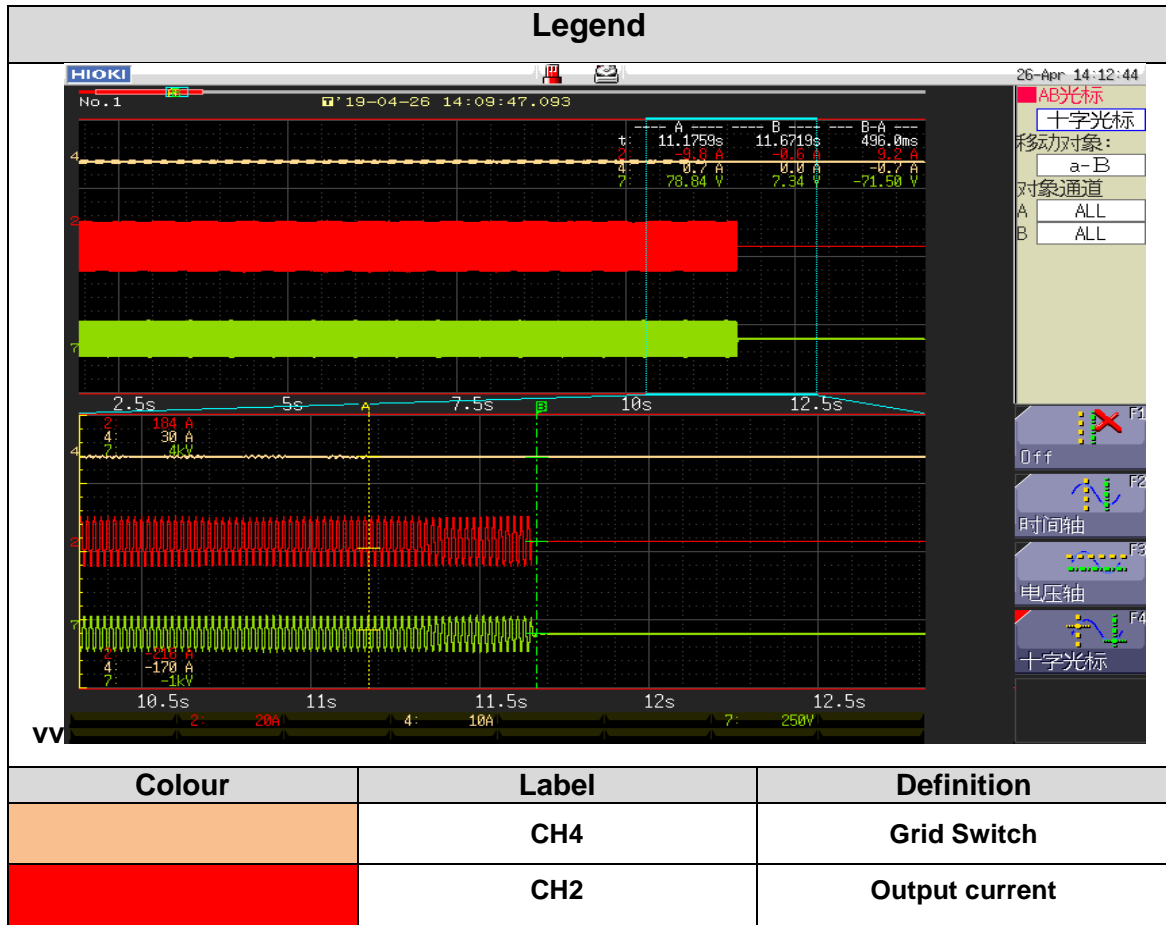

Test A(50Hz)

M(%)=0 & N(%)=0

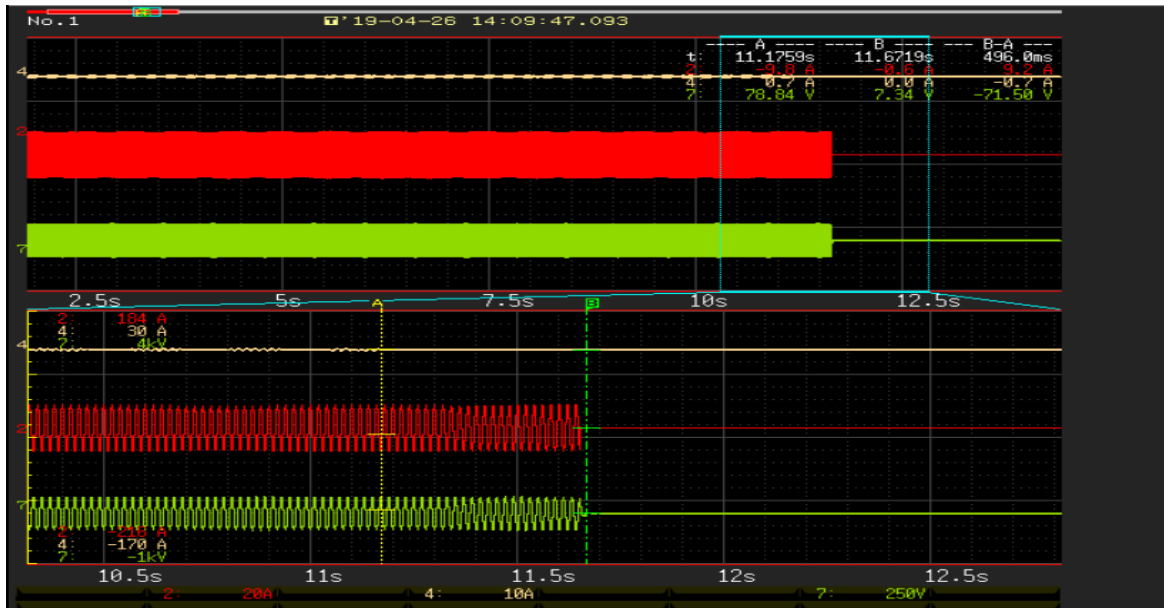

Test A(50Hz)

M(%)=0 & N(%)=+5

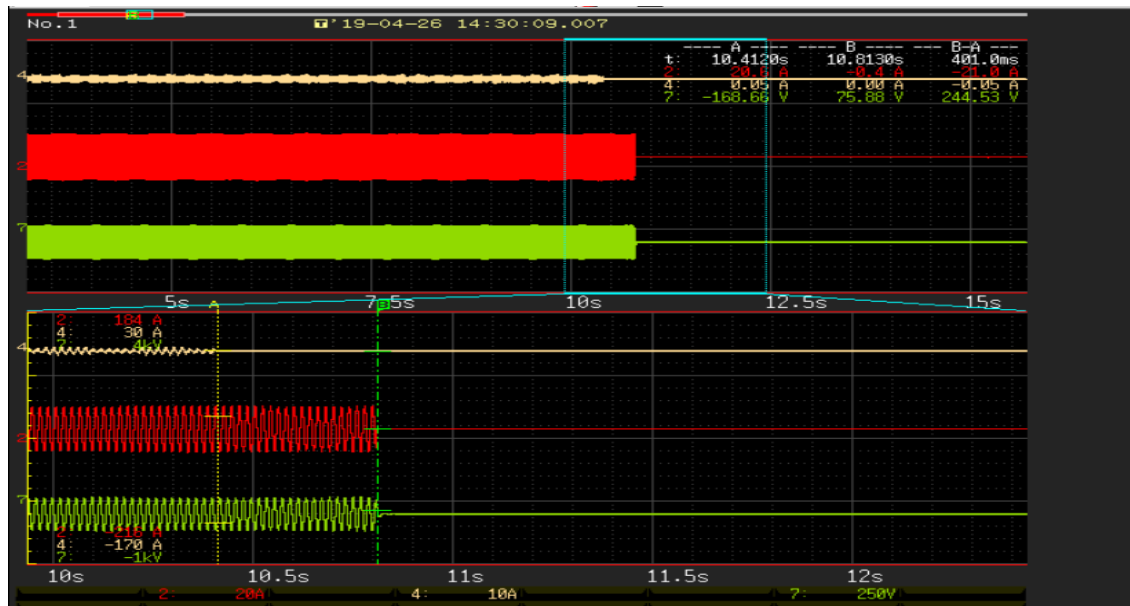

Test A(50Hz)

M(%)=0 & N(%)=-5

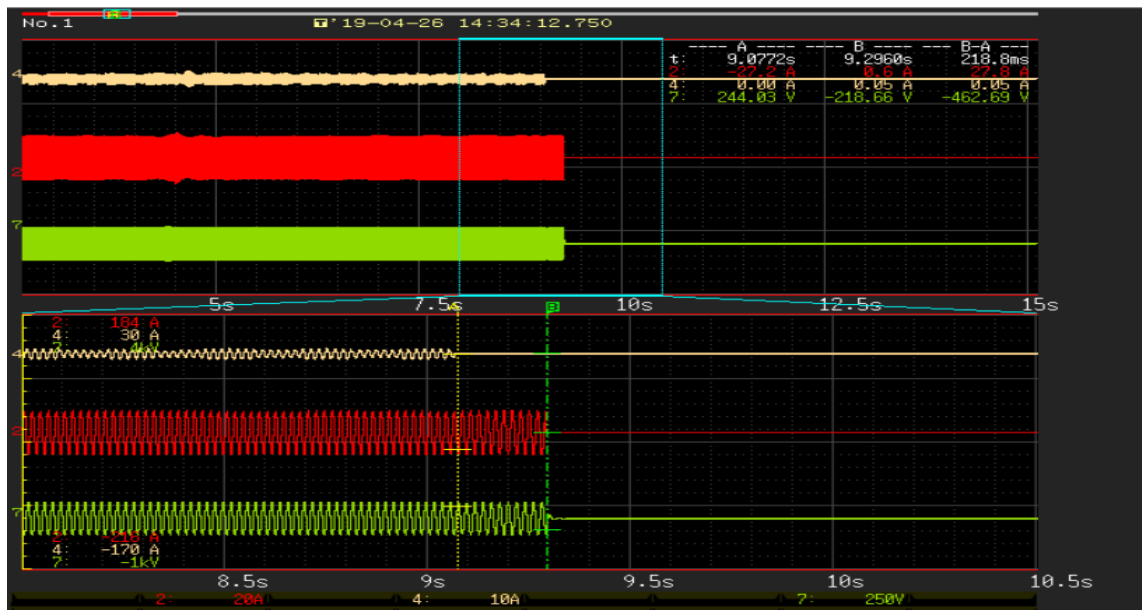

Test A(50Hz)

M(%)=+5 & N(%)=0

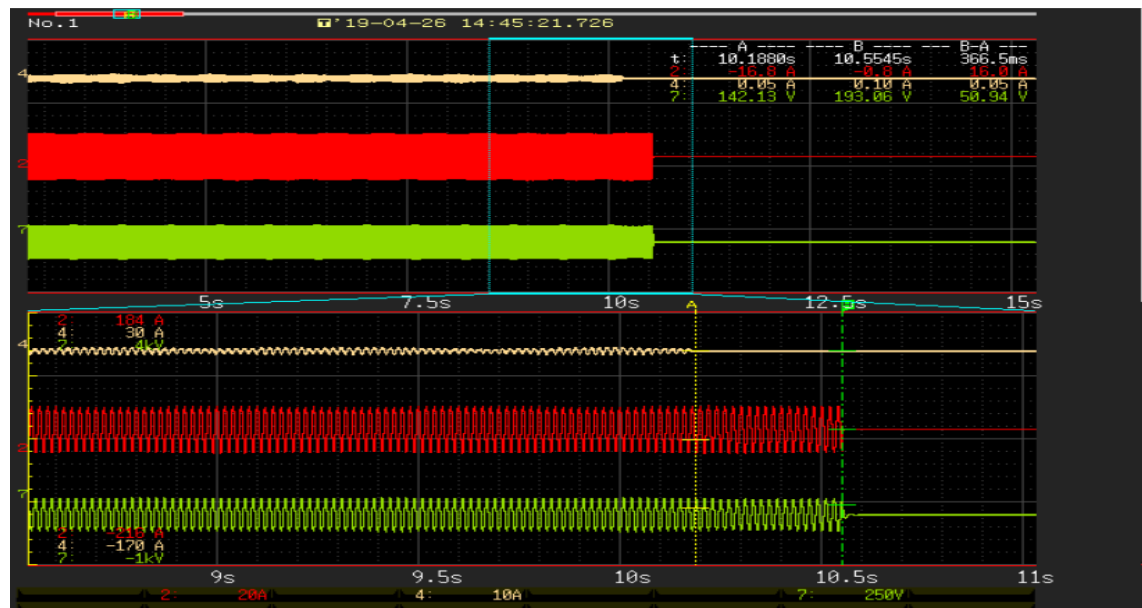

Test A(50Hz)

M(+)=+5 & N(+)=+5

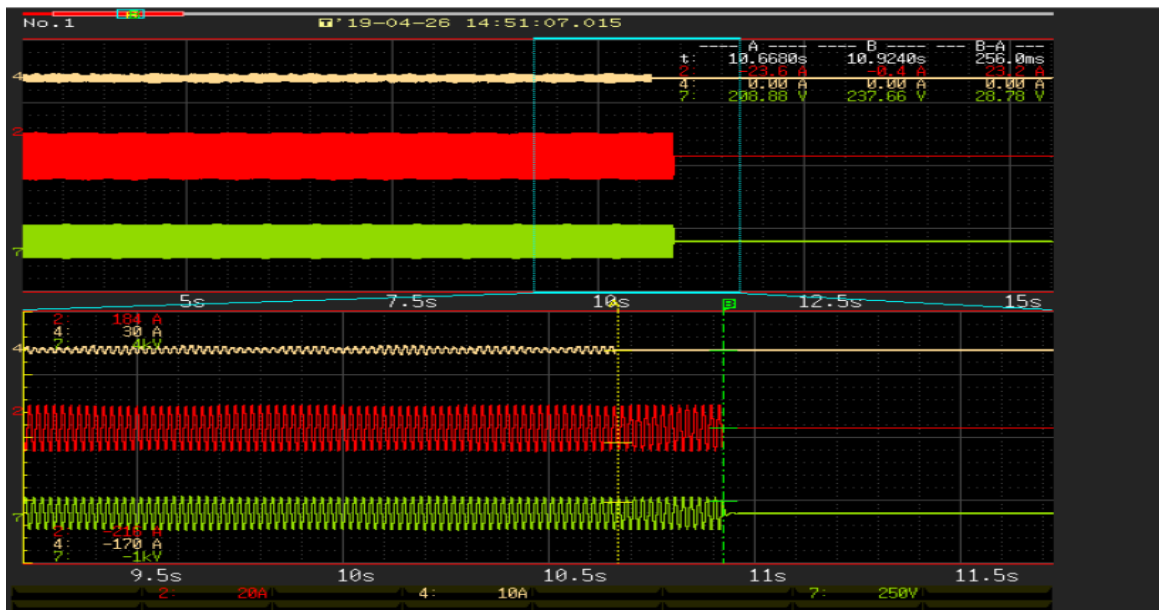

Test A(50Hz)

M(+)=+5 & N(+)=-5

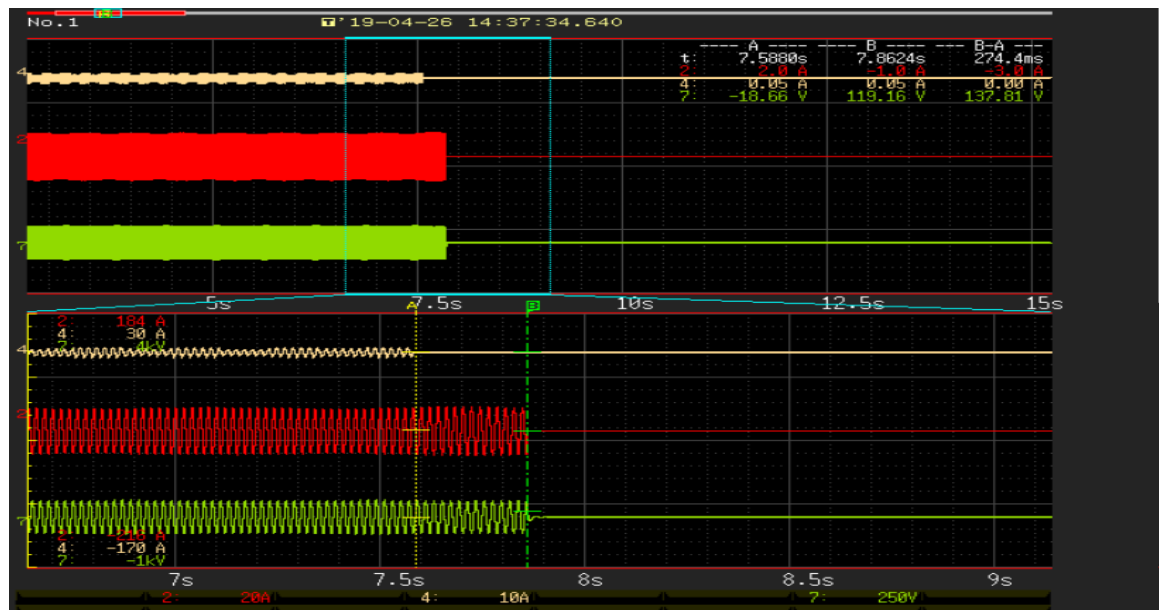

Test A(50Hz)

M(%)=-5 & N(%)=0

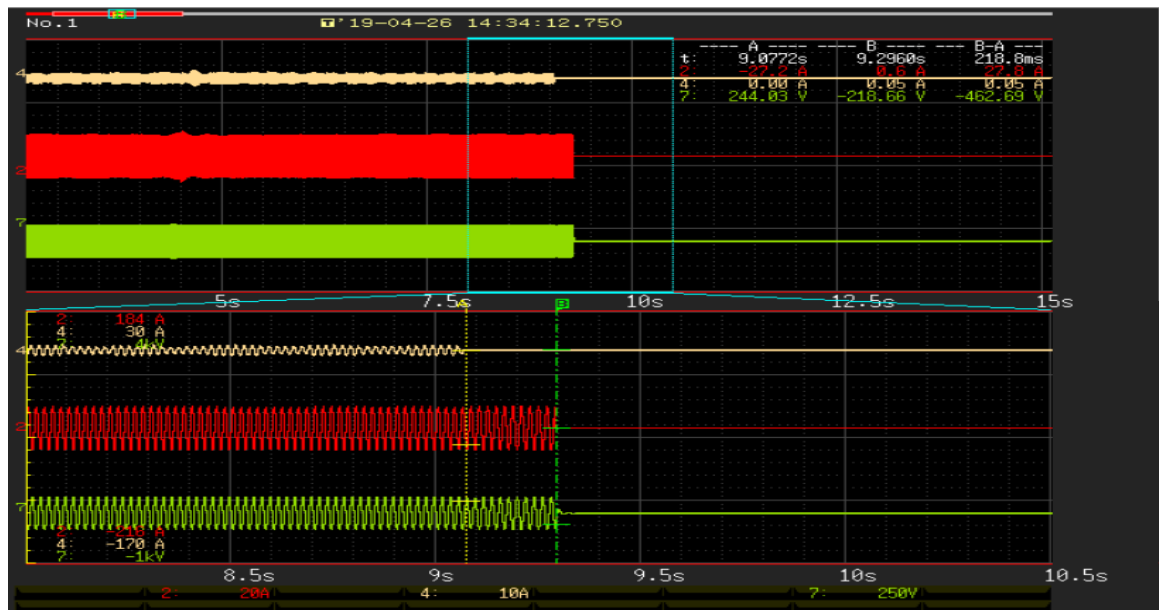

Test A(50Hz)

M(%)=-5 & N(%)=+5

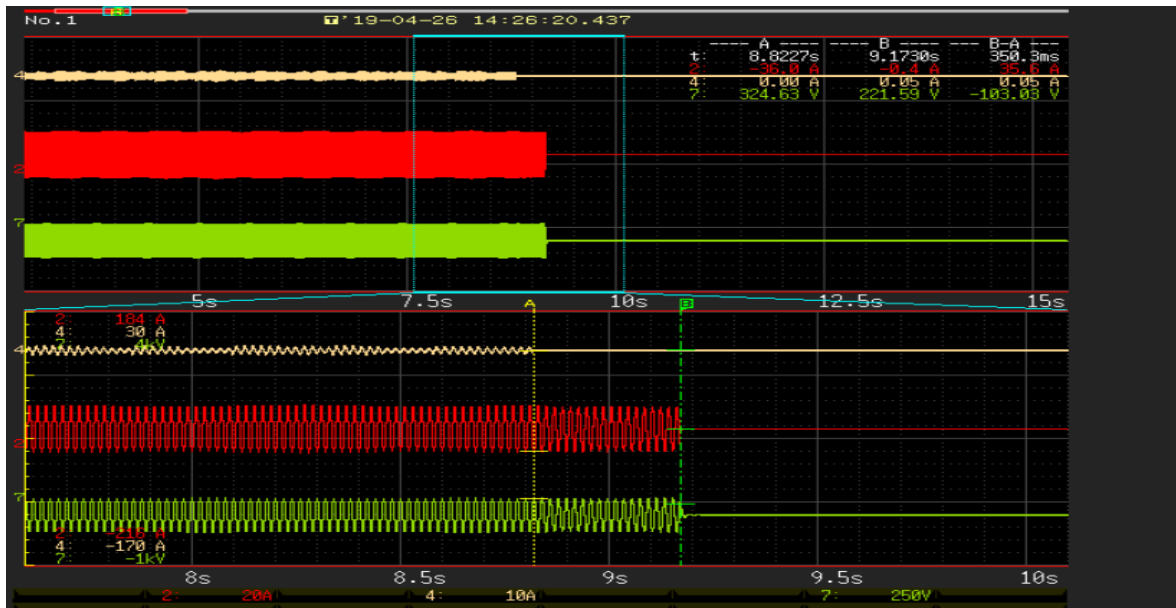

Test A(50Hz)

M(%)=-5 & N(%)=-5

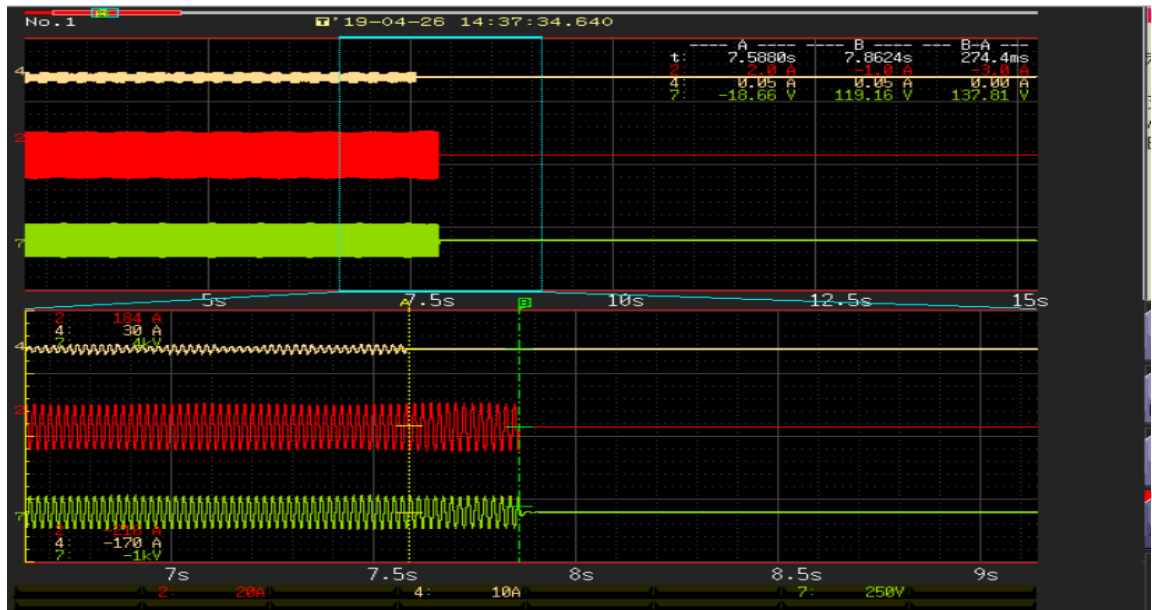

Test B(50Hz)

M(%)=0 & N(%)=0

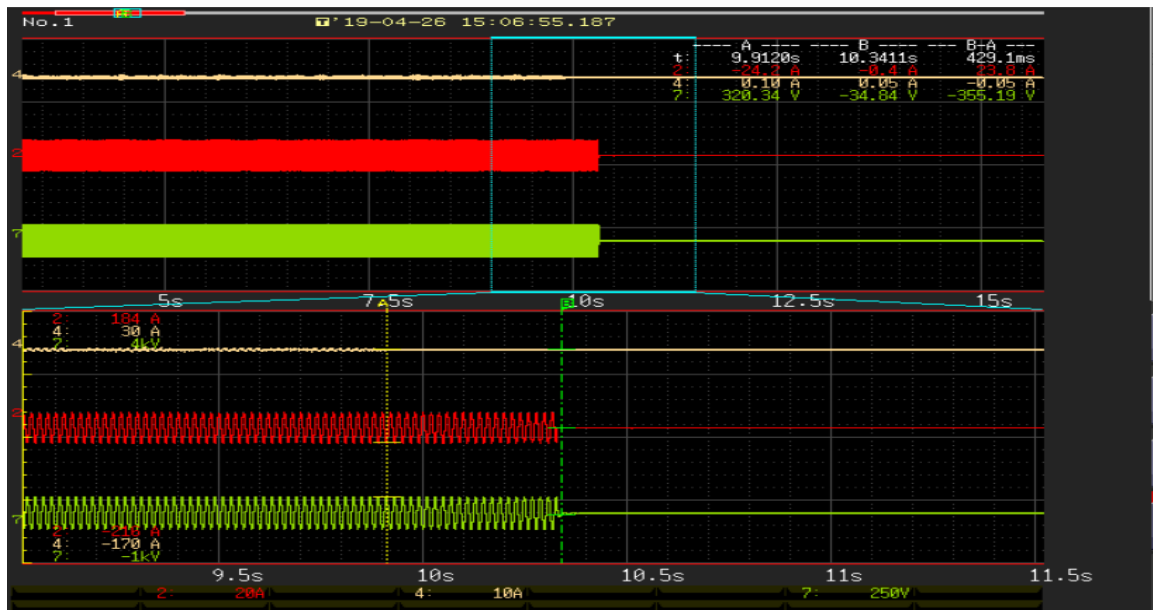

Test B(50Hz)

M(%)=0 & N(%)=+1

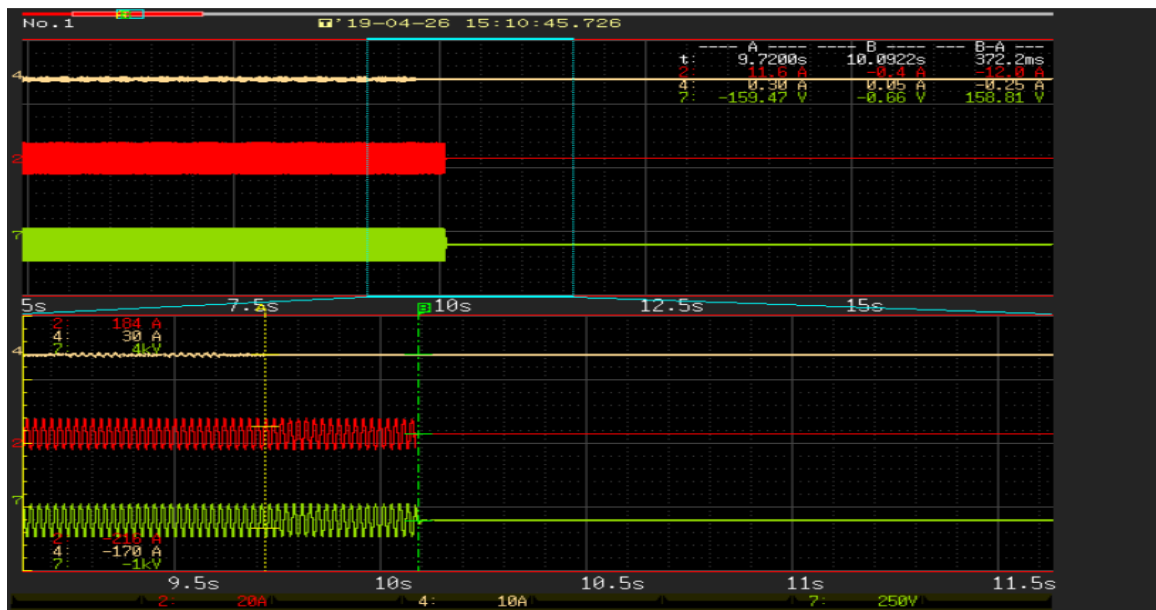

Test B(50Hz)

M(%)=0 & N(%)=+2

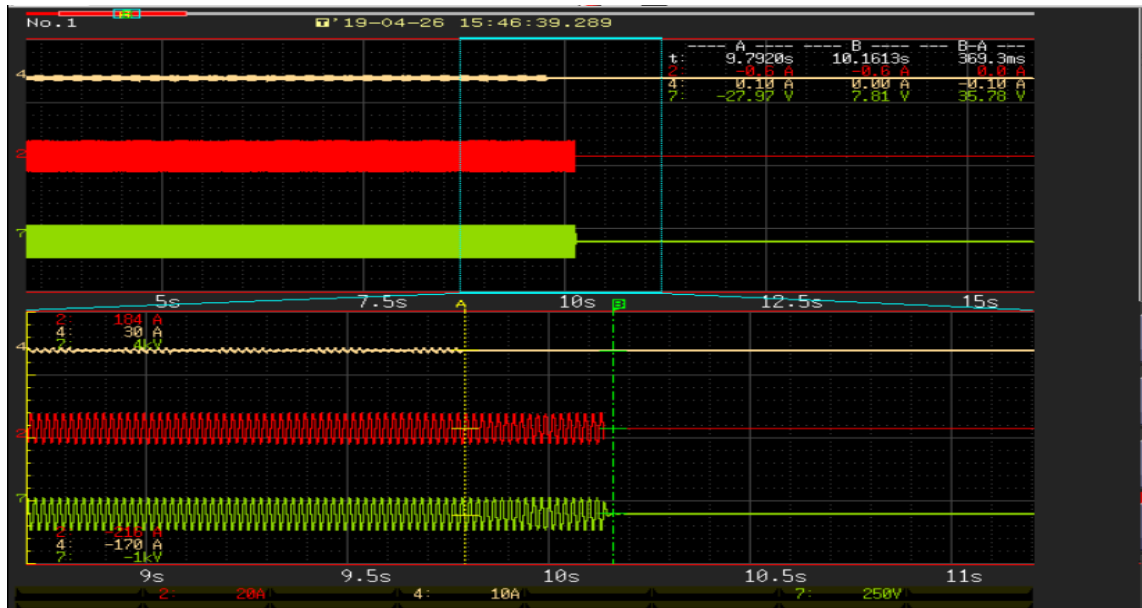

Test B(50Hz)

M(%)=0 & N(%)=+3

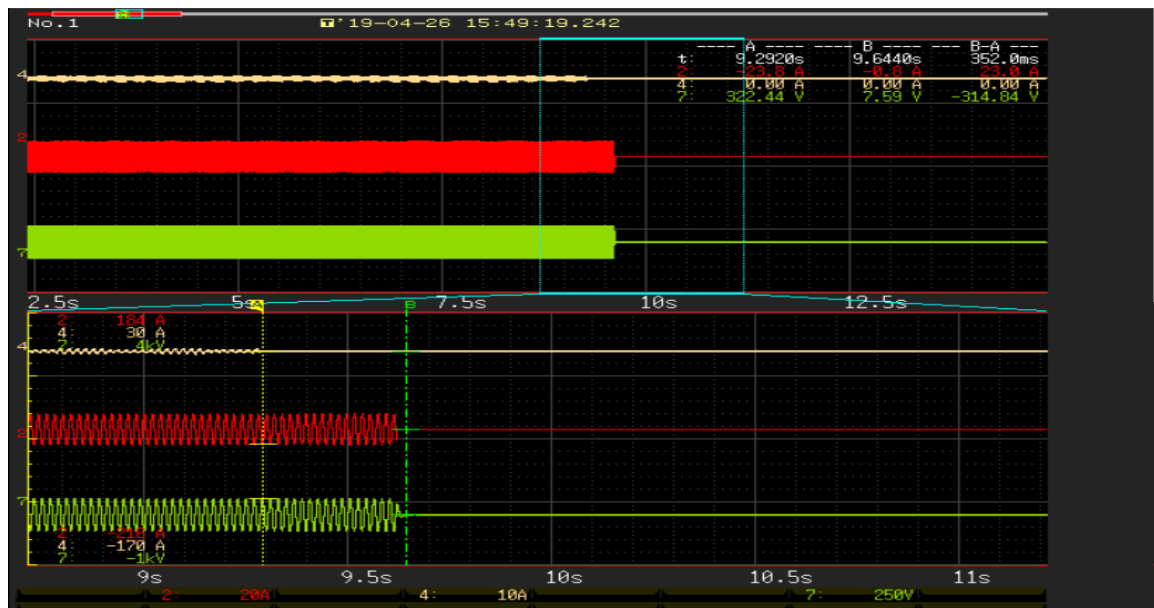

Test B(50Hz)

M(%)=0 & N(%)=+4

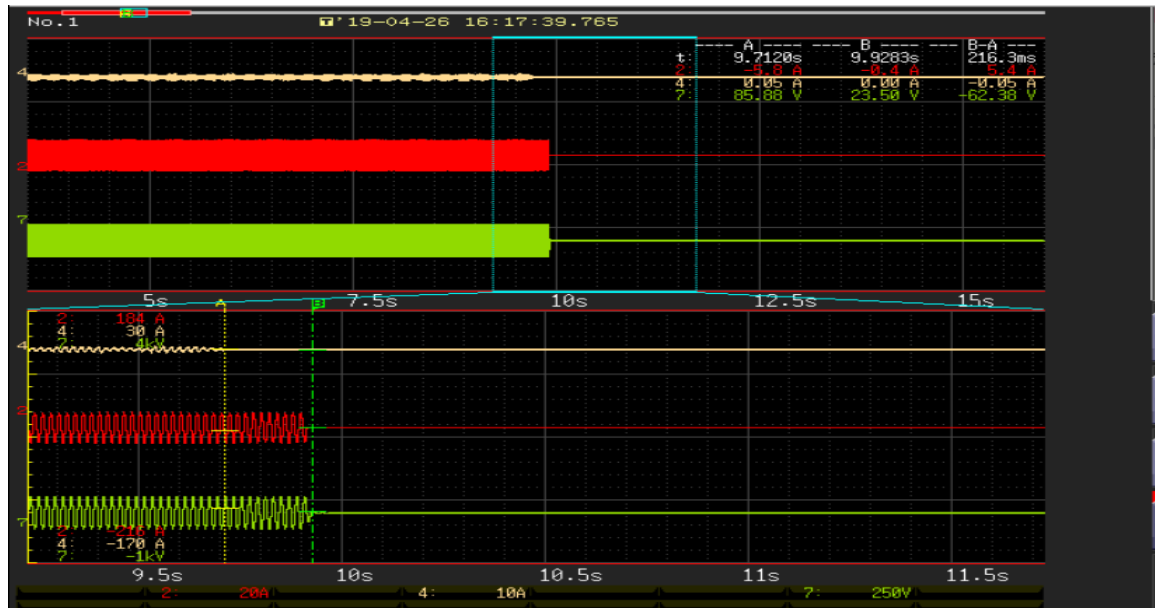

Test B(50Hz)

M(%)=0 & N(%)=+5

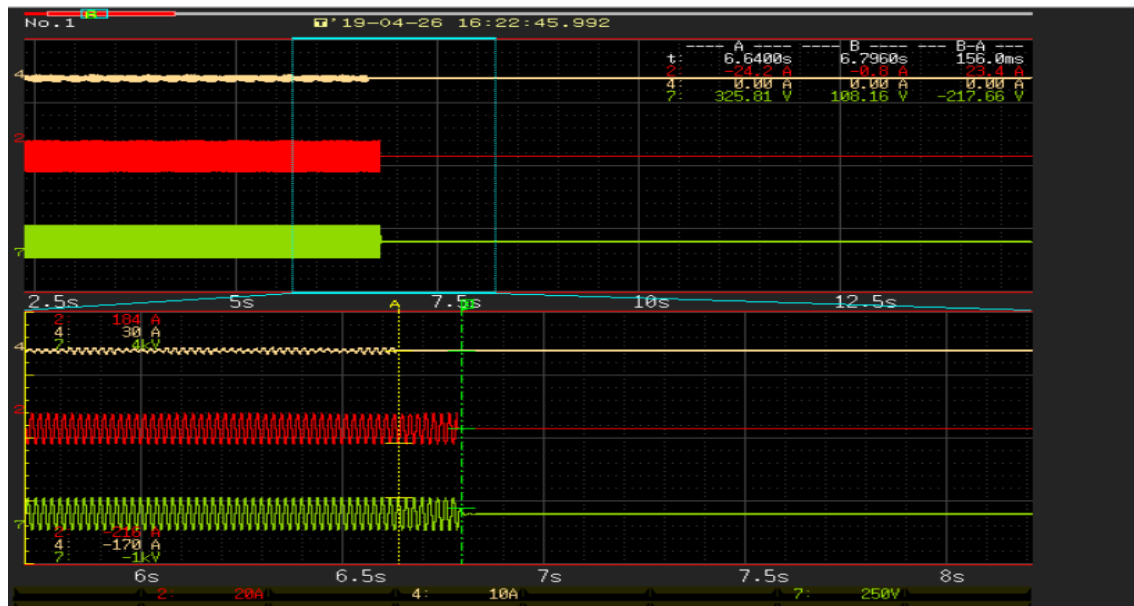

Test B(50Hz)

M(%)=0 & N(%)=-1

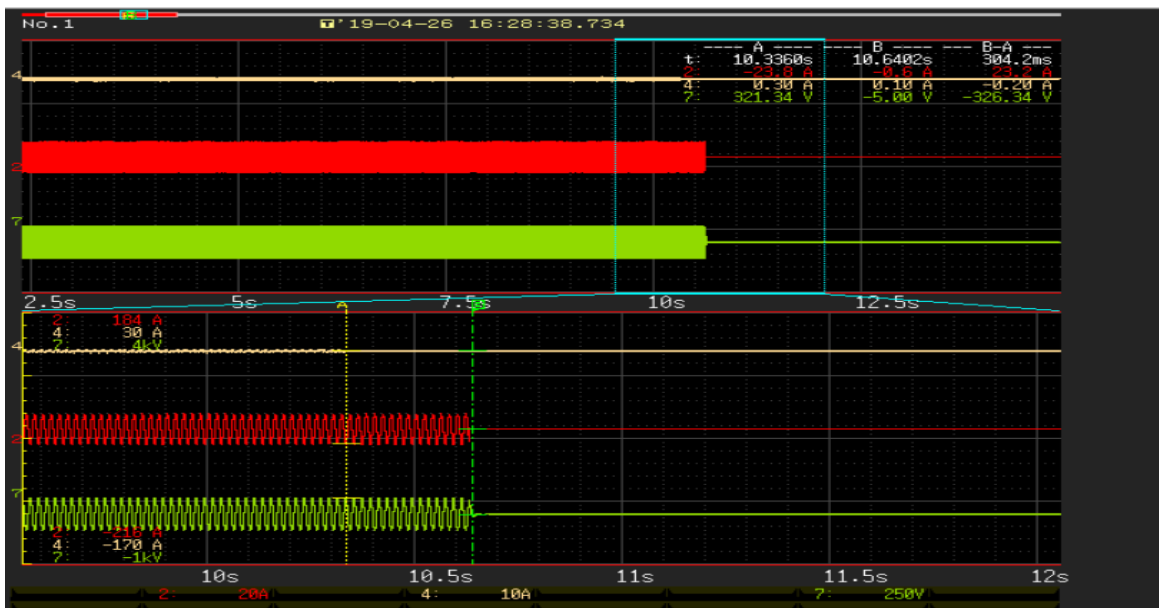

Test B(50Hz)

M(%)=0 & N(%)=-2

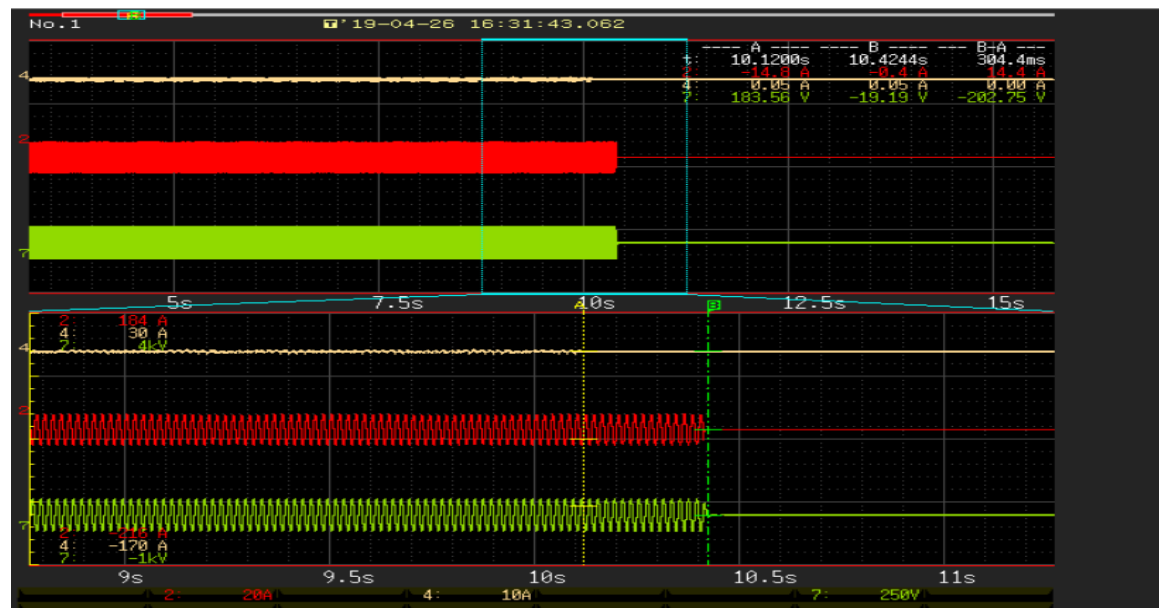

Test B(50Hz)

M(%)=0 & N(%)=-3

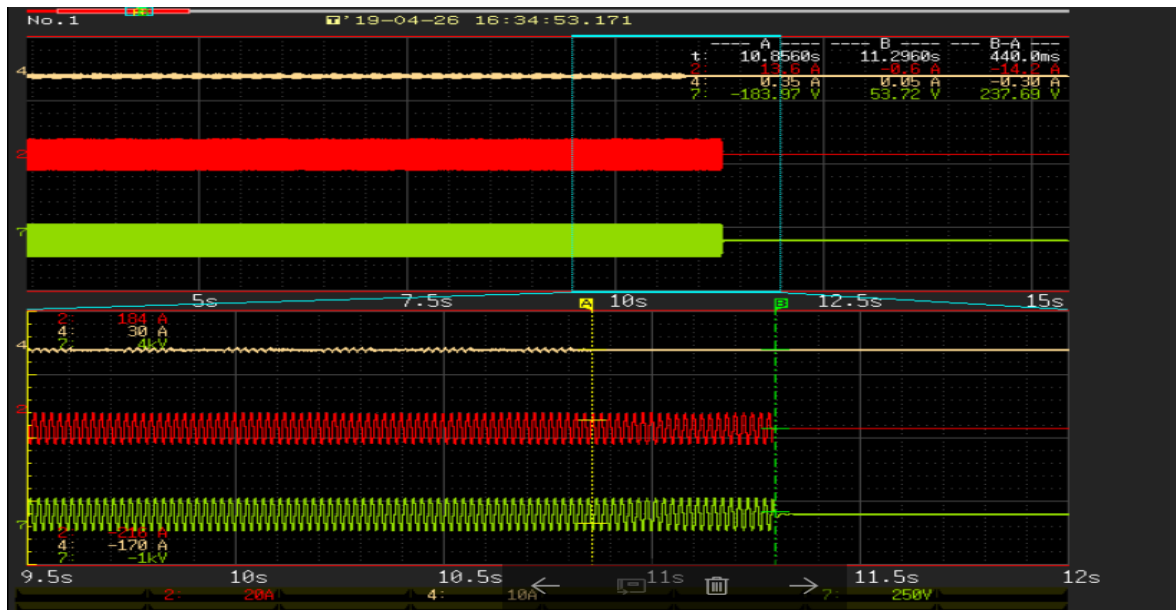

Test B(50Hz)

M(%)=0 & N(%)=-4

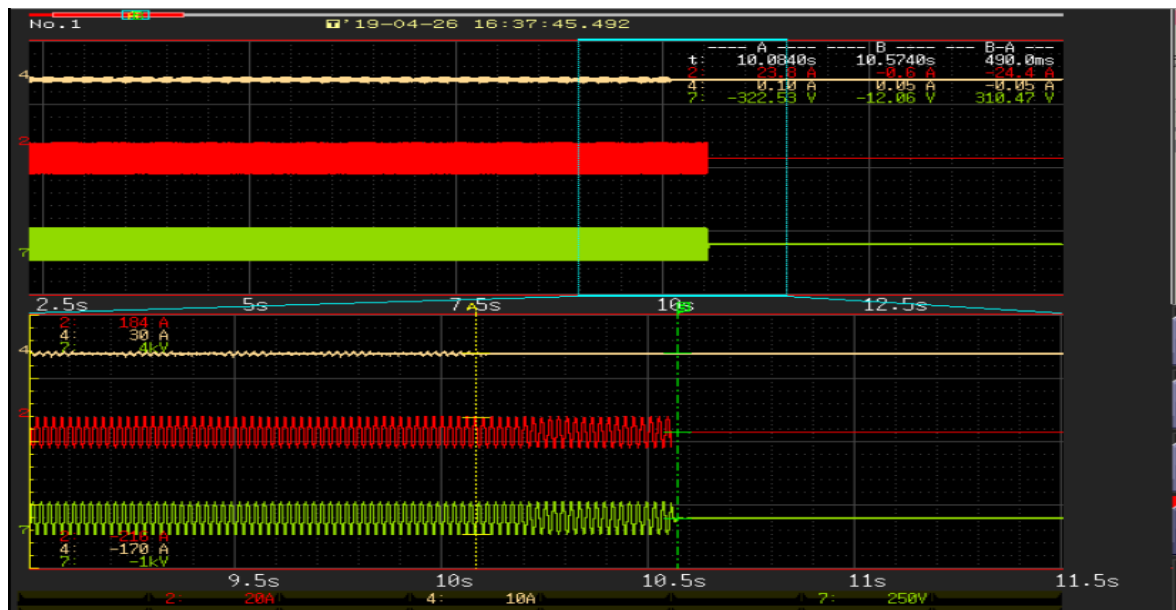

Test B(50Hz)

M(%)=0 & N(%)=-5



Test C(50Hz)

M(%)=0 & N(%)=0

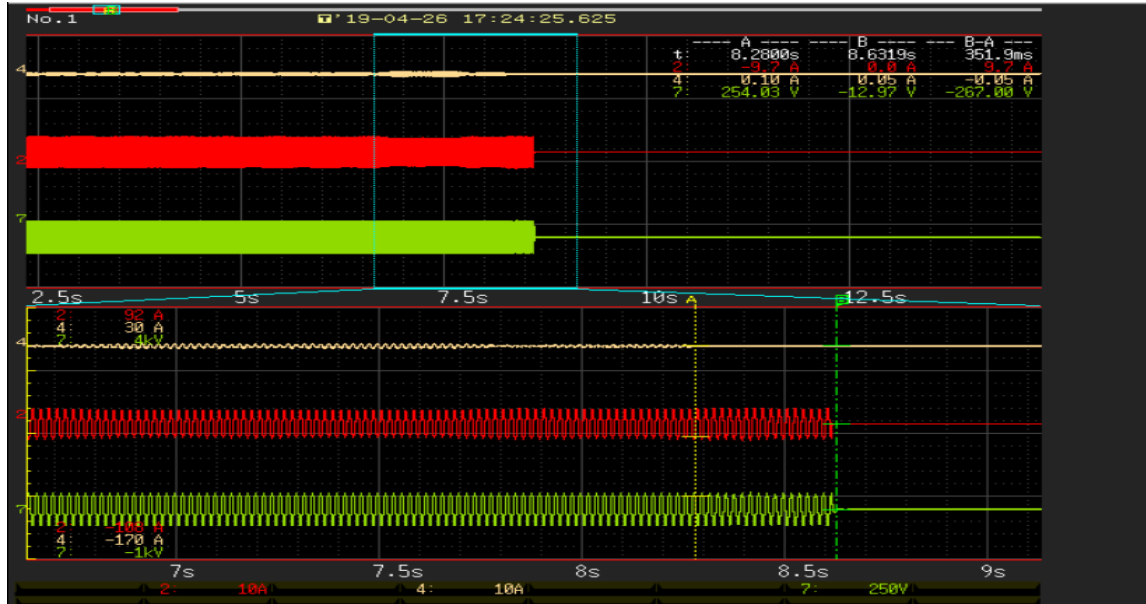

Test C(50Hz)

M(%)=0 & N(%)=+1

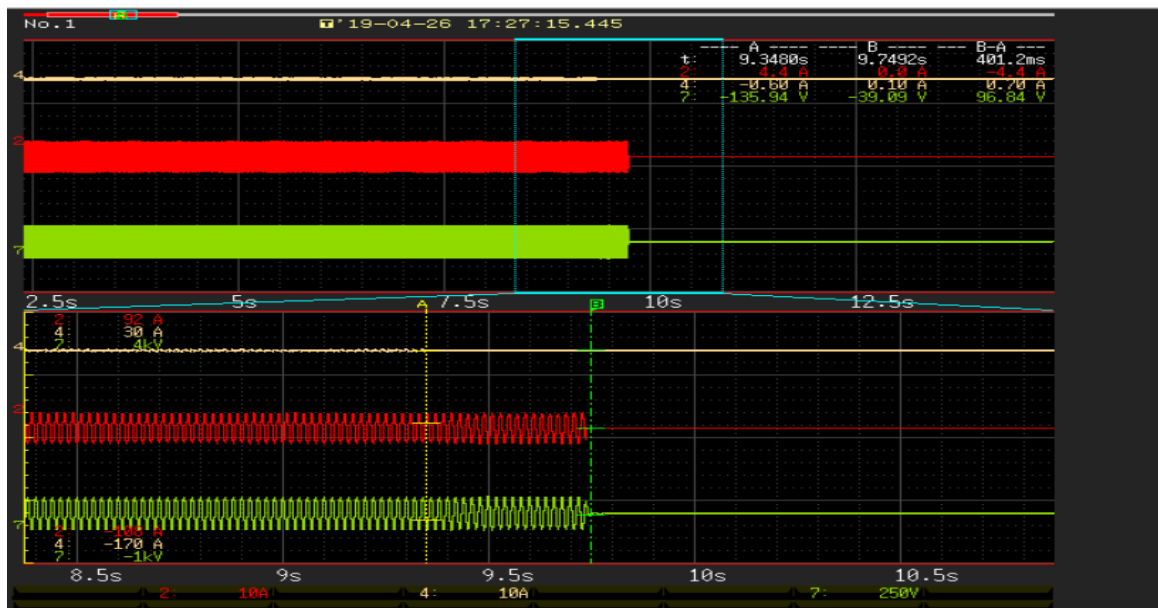

Test C(50Hz)

M(%)=0 & N(%)=+2

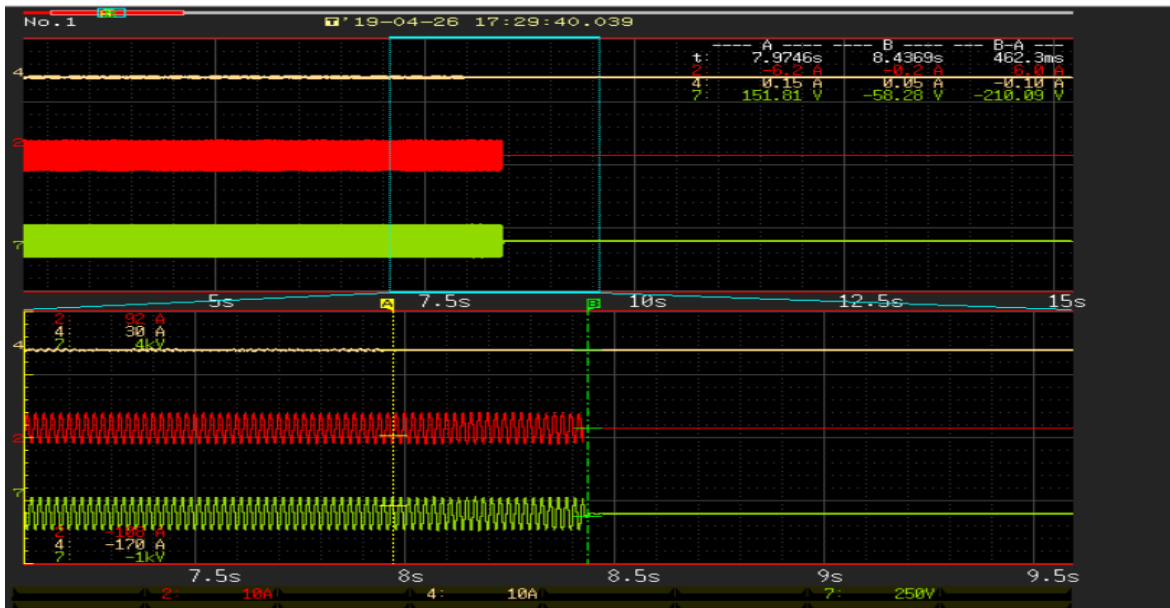

Test C(50Hz)

M(%)=0 & N(%)=+3

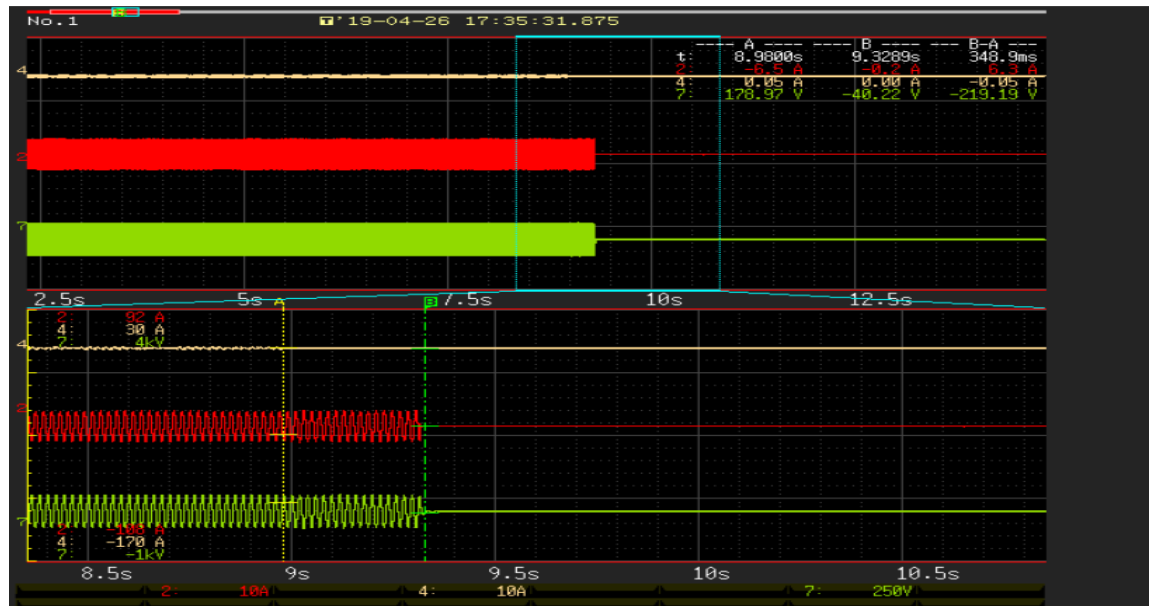

Test C(50Hz)

M(%)=0 & N(%)=+4

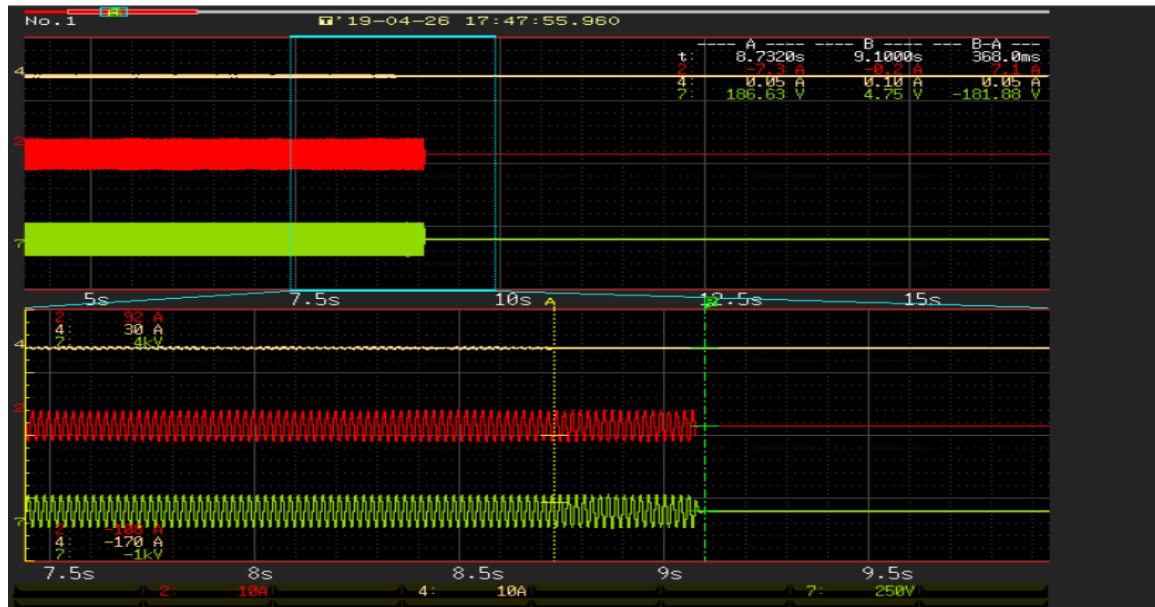

Test C(50Hz)

M(%)=0 & N(%)=+5

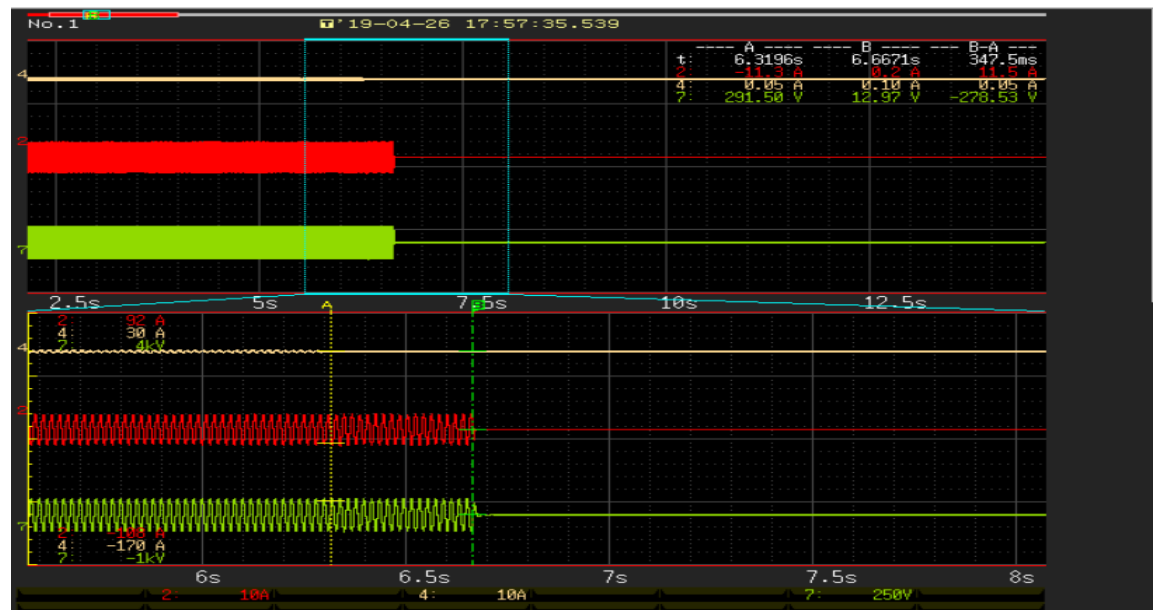

Test C(50Hz)

M(%)=0 & N(%)=-1



Test C(50Hz)

M(%)=0 & N(%)=-2

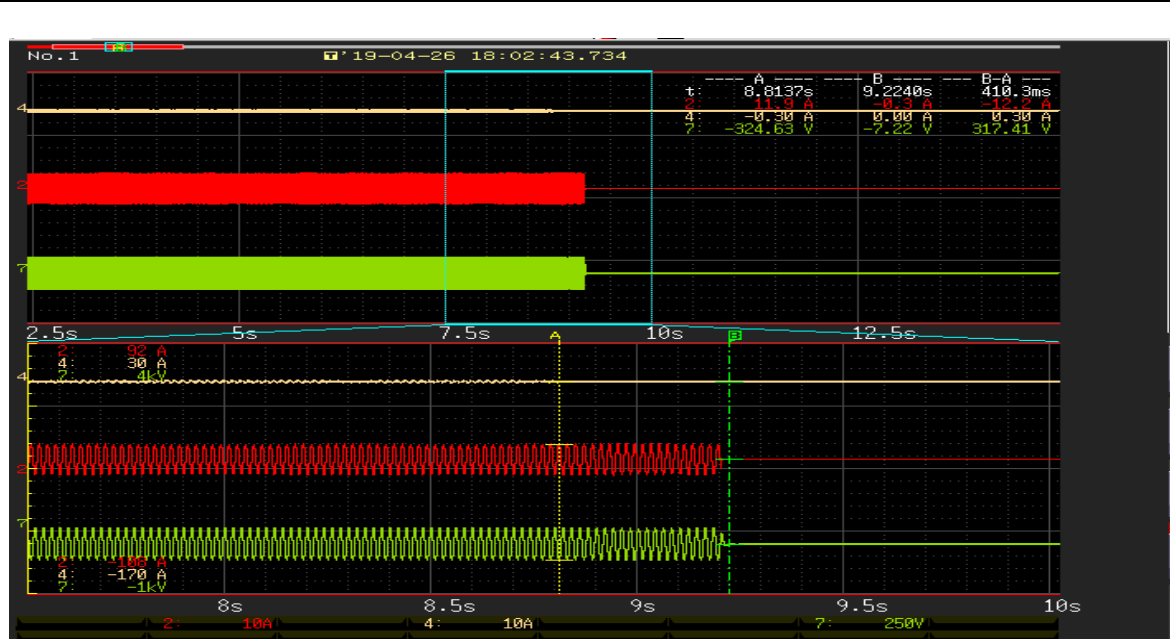

Test C(50Hz)

M(%)=0 & N(%)=-3

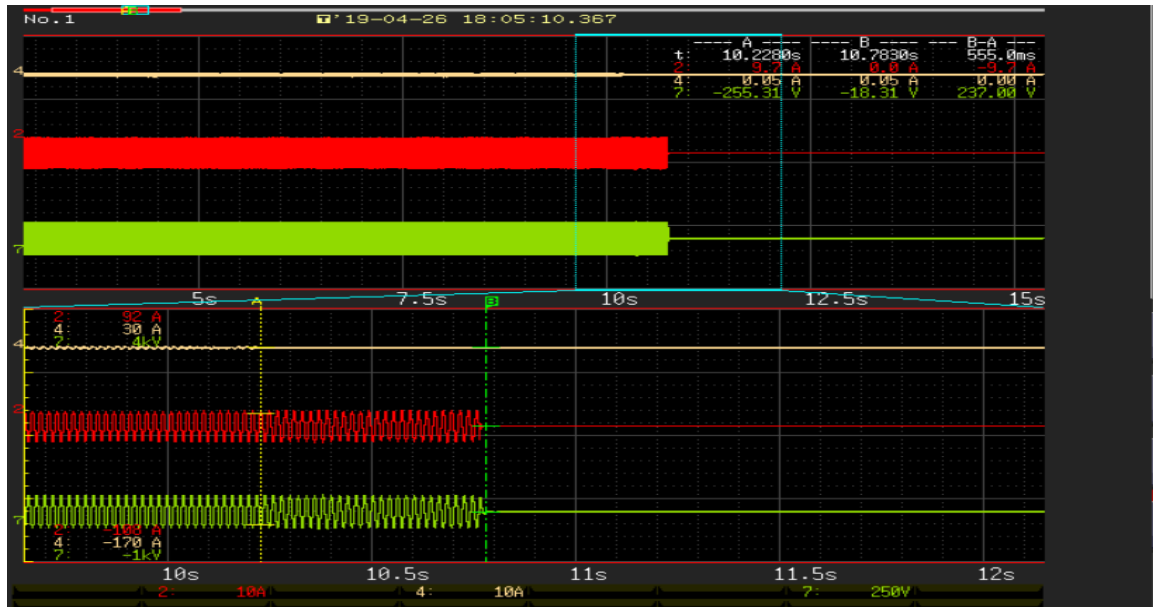

Test C(50Hz)

M(%)=0 & N(%)=-4

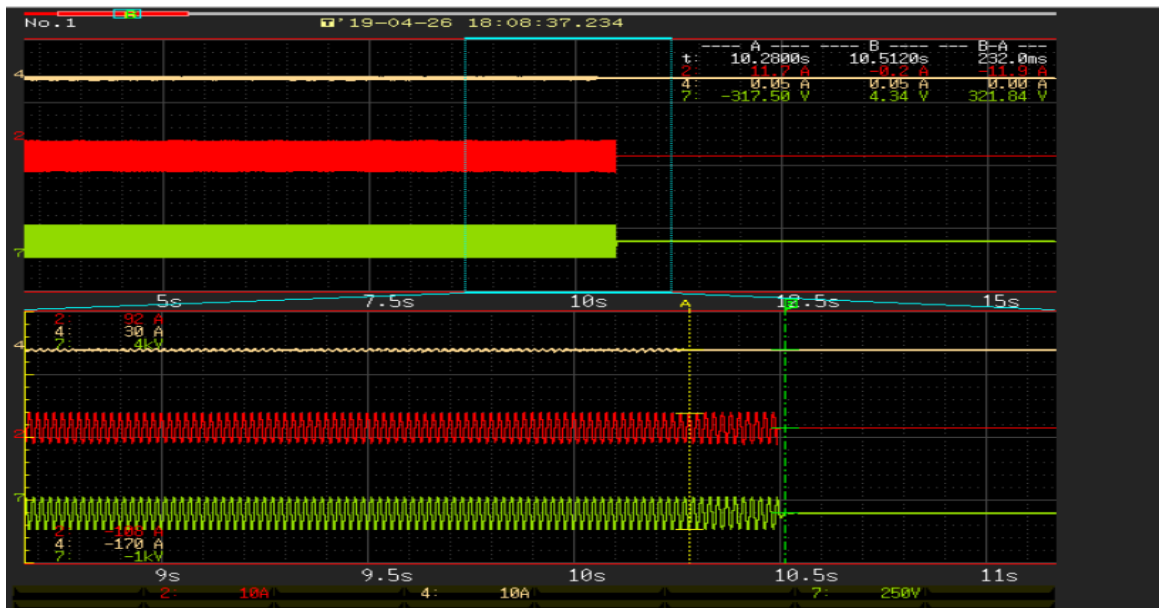

Test C(50Hz)

M(%)=0 & N(%)=-5

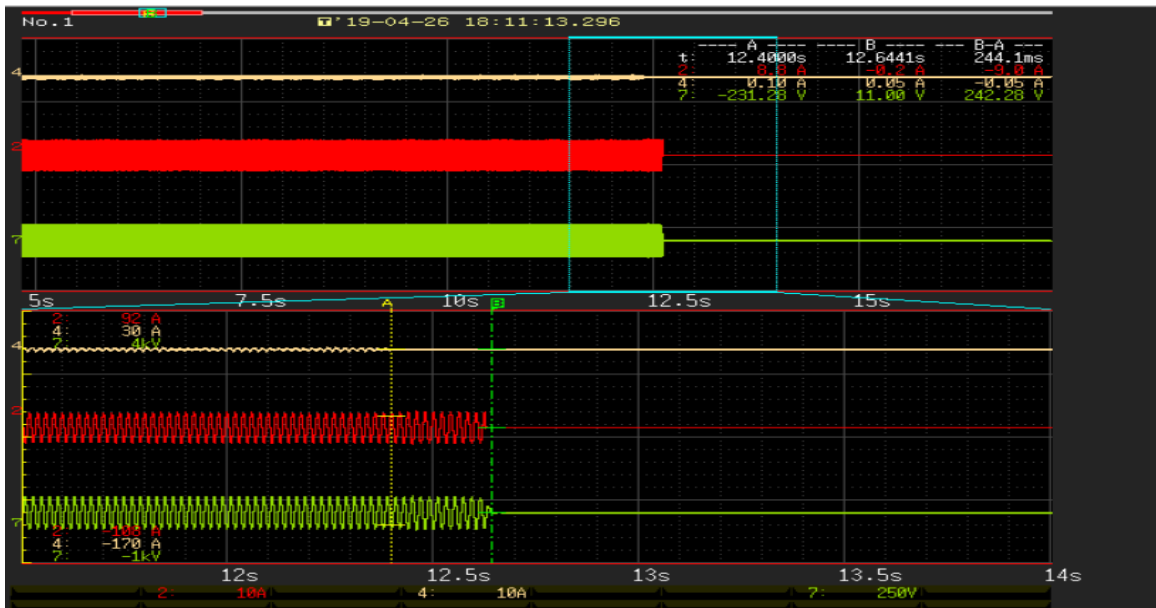

Test C(50Hz)

M(%)=0 & N(%)=-6

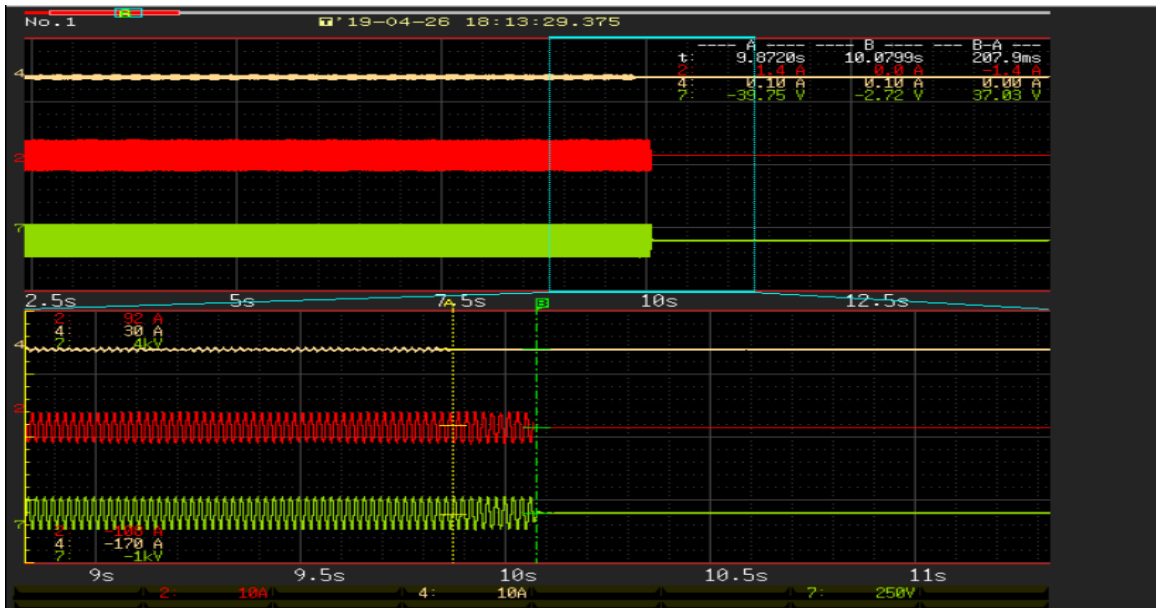

ATTACHMENT IV

(Testing information)

IEC 62116:2014 (50Hz)

1 TESTING CIRCUIT

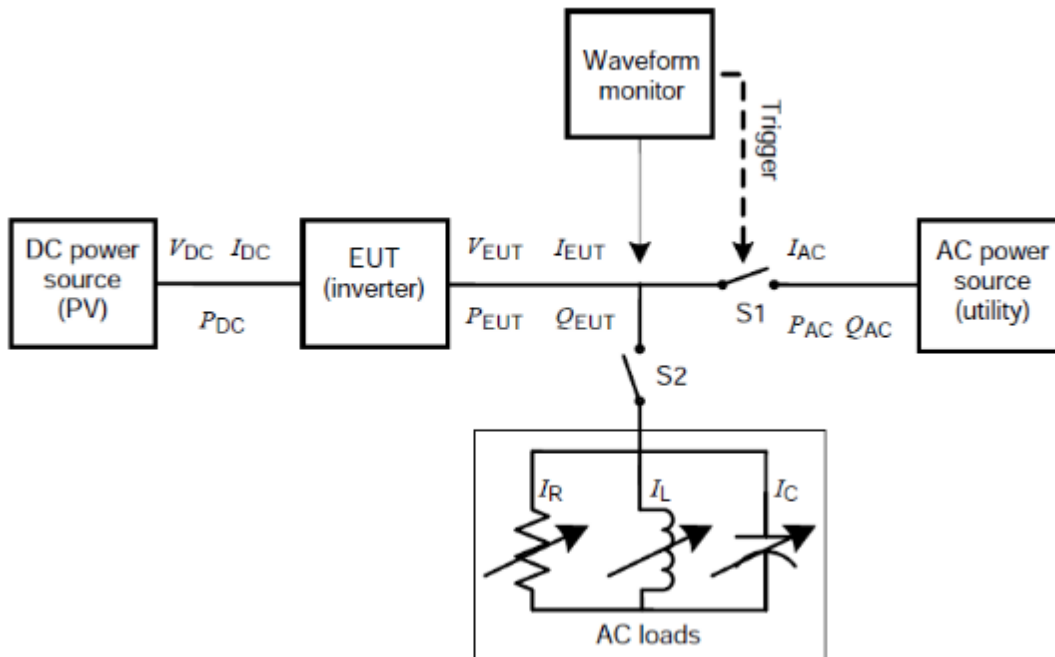

Current and voltage clamps have been connected to the inverter input/output for all the tests.

All the tests and checks have been performed in accordance with the reference standard under testing.

2 TESTING EQUIPMENT

From	No.	Equipment Name	Model No.	Equipment No.	Equipment calibration due date
Ba Lun	1	Current clamp	CT6863-05	BZ-EP-L006	2020/2/27
	2	Current clamp	CT6863-05	BZ-EP-L007	2020/2/27
	3	Digital oscilloscope	MS04054B	BZ-EP-L016	2020/2/25
	4	Power analyzer	PW6001-16	BZ-EP-L005	2020/2/26
	5	Power analyzer	PA6006H	BZ-EP-L051	2019/11/04
	6	Differential probe	DP6130	BZ-SFT-L061	2019/11/04
	7	Temperature & Humidity meter	DT-322	BZ-DGD-L005	2020/03/08
	8	Temperature & Humidity Chamber	8m3	BZ-KKX-L018	2019/11/01
	9	AC source	KACM-75-33	BZ-EP-L001	--
	10	PV array simulator	WLPA-150KW	BZ-DGD-L013	--
	11	RLC load	ACLT-38160H	BZ-DGD-L003	--
SGS	12	True RMS Multimeter	Fluke / 289C	GZE012-53	2020/02/26

Items	Specifications
1) PV array simulator	
a) Voltage range	0 – 1000Vdc (0.01V step)
b) Current range	0 – 40A (0.01A step)
2) AC power source	
a) Output wiring	Three phase
b) Output capacity	30KVA
c) Output voltage	10-300Vrms
d) Output frequency	45-65Hz
e) Voltage stability	± 100ppm/°C
f) Output voltage distortion	0.05% max.
3) Digital meter	
a) Voltage range	0 – 1000Vdc, 0 – 600Vrms
b) Current range	0 – 30A
c) Frequency range (accuracy)	0.2%
d) Measurement items	Voltage (V) Current (A) Active power (W) Reactive power (Var) Volt-ampere (VA) Power factor (PF) Frequency (Hz)

IEC 62116:2014 (50Hz)

	Electric energy (Wh)
4) Waveform recorder	
a) Sampling speed	1M/s
b) Recording device	Memory record and USB reading
c) Time accuracy	± 500ppm
5) AC load	
a) Resistive load	Maximum voltage: 300Vrms Current range: 0 – 100A Capacity: 30KW
b) Inductive load	Maximum voltage: 300Vrms Current range: 0 – 100A Capacity: 30KVA
c) Capacitive load	Maximum voltage: 300Vrms Current range: 0 – 100A Capacity: 30KVA

3 MEASUREMENT UNCERTAINTY

Magnitude	Uncertainty
Voltage measurement	±1.5 %
Current measurement	±2.0 %
Frequency measurement	±0.2 %
Time measurement	±0.2 %
Power measurement	±2.5 %
Phase Angle	±1°
Temperature	±3° C

Note1: Measurements uncertainties showed in this table are maximum allowable uncertainties. The measurement uncertainties associated with other parameters measured during the tests are in the laboratory at disposal of the petitioner.

Note2: Where the standard requires lower uncertainties that those in this table. Most restrictive uncertainty has been considered.